



BOARD OF COUNTY COMMISSIONERS
WARREN COUNTY, OHIO

406 Justice Drive, Lebanon, Ohio 45036

www.co.warren.oh.us

commissioners@co.warren.oh.us

Telephone (513) 695-1250

Facsimile (513) 695-2054

SHANNON JONES
DAVID G. YOUNG
TOM GROSSMANN

**ENTERING INTO CONTRACT WITH W.E. SMITH CONSTRUCTION FOR THE 2024
HAMILTON ROAD DRILLED PIER WALL PROJECT**

WHEREAS, pursuant to Resolution #24-1116, adopted August 27, 2024, this Board approved a Notice of Intent to Award Contract for the 2024 Hamilton Road Drilled Pier Wall Project to W.E. Smith Construction, for a total contract price of \$184,857.00; and

WHEREAS, all documentation, including performance bonds, insurance certificates, etc., has been submitted by the contractor; and

NOW THEREFORE BE IT RESOLVED, to enter into contract with W.E. Smith Construction, for said project, for a total contract price of \$184,857.00; as attached hereto and made a part hereof.

Mr. Grossmann moved for adoption of the foregoing resolution being seconded by Mrs. Jones. Upon call of the roll, the following vote resulted:

Mr. Young – yea

Mrs. Jones – yea

Mr. Grossmann – yea

Resolution adopted this 24th day of September 2024.

BOARD OF COUNTY COMMISSIONERS

Krystal Powell, Clerk

KP

cc: c/a— W.E. Smith Construction
Engineer (file)
OMB Bid file



BOARD OF COUNTY COMMISSIONERS
WARREN COUNTY, OHIO

406 Justice Drive, Lebanon, Ohio 45036

www.co.warren.oh.us

commissioners@co.warren.oh.us

Telephone (513) 695-1250

Facsimile (513) 695-2054

SHANNON JONES
DAVID G. YOUNG
TOM GROSSMANN

**APPROVING NOTICE OF INTENT TO AWARD BID TO W.E. SMITH CONSTRUCTION
FOR THE 2024 HAMILTON ROAD DRILLED PIER WALL PROJECT**

WHEREAS, bids were closed at 9:30 a.m., on August 14, 2024, and the bids received were opened and read aloud for the 2024 Hamilton Road Drilled Pier Wall Project, and the results are on file in the Commissioners' Office; and

WHEREAS, upon review of such bids by Logan Smith, Project Engineer, W.E. Smith Construction has been determined to be the lowest and best bidder.

NOW THEREFORE BE IT RESOLVED, upon recommendation of the Warren County Engineer, that it is the intent of this Board to award the contract to W.E. Smith Construction, 2030 Bauer Road, Blanchester, Ohio 45107, for a total bid price of \$184,857.00; and

BE IT FURTHER RESOLVED, that the President of the Board is hereby authorized to execute a "Notice of Intent to Award."

Mrs. Jones moved for adoption of the foregoing resolution being seconded by Mr. Grossmann. Upon call of the roll, the following vote resulted:

Mr. Young – yea

Mr. Grossmann – yea

Mrs. Jones – yea

Resolution adopted this 27th day of August 2024.

BOARD OF COUNTY COMMISSIONERS

Krystal Powell, Clerk

cc: Engineer (file)
OMB Bid file



August 5, 2024

Re: Addendum No. 1 – 2024 Hamilton Road Pier Wall Project

Dear Prospective Bidder:

Listed below is Addendum No. 1 for the referenced project. Please note the following clarifications/modifications to be included in your bid price. The bid opening for this project will remain as scheduled Wednesday, August 14, 2024, at 9:30 am at the Warren County Commissioners, 406 Justice Drive, Lebanon, Ohio 45036.

ADDENDUM NO. 1

1. Clarification/Modification: (Plans and Specifications)

As per the technical specifications, the Armormax 75 shall only be installed from the edge of the proposed pier wall to 30 feet from the center of the road, as these are the limits of the right-of-way. Do not disturb the fence on the east side of the roadway, which is outside of the right-of-way. The plans do not show this correctly, so please install the Armormax 75 based on this statement.

2. Clarification/Modification: (Technical Specifications)

Please see below for added item on the technical specifications.

Item 832 – Erosion Control

The Contractor shall furnish and install temporary sediment and erosion control best management practices required prior to any earth disturbing activity in accordance with Supplemental Specification 832. All pollution prevention measures must be maintained for the duration of construction. Silt fence will be required, extending over the entire length of the pier wall. The Contractor shall remove all best management practices before the project is accepted. Payment for this work shall follow Supplemental Specification 832 and will be included in the bid price per Each for Item 832 Erosion Control. This price is standard for all bidders, set at \$1.00 Each for a total of \$1,000.00 total.

3. Clarification/Modification: (Bid Proposal)

Please remove existing Bid Proposal and use the attached updated Bid Proposal when submitting your bid.

WARREN COUNTY ENGINEER'S OFFICE

ADMINISTRATION and ENGINEERING
210 W Main St. Lebanon, OH 45036
Telephone (513) 695-3301 Fax (513) 695-7714

HIGHWAY MAINTENANCE, PERMITS, and INSPECTION
105 Markey Rd. Lebanon, OH 45036
Telephone (513) 695-3336 Fax (513) 695-3323

Addendum No. 1 shall be signed and included with the submission of the bid. Please sign below and enter the date you received this addendum. **Any bid submitted without the signed Addendum No. 1 shall be rejected.** If you have any questions, please call me at 513-695-3318.

Sincerely,

Neil F. Tunison, P.E., P.S.
WARREN COUNTY ENGINEER



Logan Smith, E.I.
Project Engineer

Received by

Signature

Company

Date

cc: file

BID PROPOSAL – cont.

Proposal for the drilled pier wall and roadway work on Hamilton Road. This work consists of constructing the drilled pier wall and the related items for the 2024 Hamilton Road Drilled Pier Wall Project. The drilled pier wall project shall be as per plans and specifications as provided by the Warren County Engineer.

The undersigned do hereby propose to furnish all labor, materials, tools, equipment, etc., necessary to construct this project for the Warren County Engineer’s Office. The above quotations to be in full force and effect for sixty (60) days after the date of opening bids. The full name and address of all persons and parties interested in the foregoing bids as principals are as follows:

Total Bid Price \$ _____

The contract will be awarded to the best and most responsive bid based on the qualifications of the Contractor and the total price of the Total Bid.

SIGNED

PRESIDENT

COMPANY

SECRETARY

BY

TITLE

DATE

ADDRESS

**2024 HAMILTON ROAD DRILLED PIER WALL PROJECT
 BID PROPOSAL**

Item No.	Description	Quantity	Unit	Unit Cost	Total Cost
	Hamilton Road				
201	Clearing and Grubbing	1	Lump		
202	Guardrail Removed	275	FT		
203	Excavation	27	CY		
204	Subgrade Compaction	54	SY		
301	Asphalt Concrete Base PG 64-22	30	Ton		
304	Aggregate Base	14	CY		
441	Asphalt Concrete Surface Course, Type 1, (448), PG 64-22	6	Ton		
524	Drilled Shafts, 30" Diameter, Unreinforced	672	FT		
524	Drilled Shafts, 30" Diameter, Reinforced	496	FT		
606	Guardrail, Type 5	275	FT		
614	Maintaining Traffic	1	Lump		
623	Construction Layout Stakes and Surveying	1	Lump		
624	Mobilization	1	Lump		
626	Barrier Reflector, Type 2A	6	Each		
630	Removal of Ground Mounted Sign and Reset	1	Each		
642	Edge Line, 4 inch, Type 1	0.03	Mile		
659	Seeding and Mulching	80	SY		
832	Erosion Control	1	Each	\$ 1,000.00	\$1,000.00
Special	Armormax 75	1	Lump		
				Sub-Total =	

PLAN HOLDERS LIST

2024 Hamilton Road Drilled Pier Wall Project

Individuals or companies can be added to the plan holders list by contacting Jeff Stilgenbauer at jeffery.stilgenbauer@co.warren.oh.us

Name	Company	Phone Number	E-mail Address
Jenny Foley	Sunesis Construction Co.	513-326-6000	Jfoley@sunesiscc.com
Nathan Colson	The Beaver Excavating Co	330-478-2151	Nathan.Colson@beaverexcavating.com
Kendra Corsmeier	W.E. Smith Construction	513-507-1433	Kendracorsmeier.wesmith@yahoo.com
Andrew J. Kloenne	Ford Development	513-772-1521	akloenne@Forddevelopment.com
Jessie Baker	JTM Smith Construction	937-728-0524	smithconstruction@cinci.rr.com

BID/CONTRACT DOCUMENTS
2024 HAMILTON ROAD DRILLED PIER WALL PROJECT
ON BEHALF OF
NEIL F. TUNISON
WARREN COUNTY ENGINEER

WARREN COUNTY BOARD OF COMMISSIONERS
406 JUSTICE DRIVE
LEBANON, OHIO 45036
(513) 695-1250

PROPOSAL PRICE (BID) SHEET

**2024 HAMILTON ROAD DRILLED PIER WALL PROJECT
 BID PROPOSAL**

Item No.	Description	Quantity	Unit	Unit Cost	Total Cost
	Hamilton Road				
201	Clearing and Grubbing	1	Lump		
202	Guardrail Removed	275	FT		
203	Excavation	27	CY		
204	Subgrade Compaction	54	SY		
301	Asphalt Concrete Base PG 64-22	30	Ton		
304	Aggregate Base	14	CY		
441	Asphalt Concrete Surface Course, Type 1, (448), PG 64-22	6	Ton		
524	Drilled Shafts, 30" Diameter, Unreinforced	672	FT		
524	Drilled Shafts, 30" Diameter, Reinforced	496	FT		
606	Guardrail, Type 5	275	FT		
614	Maintaining Traffic	1	Lump		
623	Construction Layout Stakes and Surveying	1	Lump		
624	Mobilization	1	Lump		
626	Barrier Reflector, Type 2A	6	Each		
630	Removal of Ground Mounted Sign and Reset	1	Each		
642	Edge Line, 4 inch, Type 1	0.03	Mile		
659	Seeding and Mulching	80	SY		
Special	Armormax 75	1	Lump		
				Sub-Total =	\$ -

BID PROPOSAL – cont.

Proposal for the drilled pier wall and roadway work on Hamilton Road. This work consists of constructing the drilled pier wall and the related items for the 2024 Hamilton Road Drilled Pier Wall Project. The drilled pier wall project shall be as per plans and specifications as provided by the Warren County Engineer.

The undersigned do hereby propose to furnish all labor, materials, tools, equipment, etc., necessary to construct this project for the Warren County Engineer’s Office. The above quotations to be in full force and effect for sixty (60) days after the date of opening bids. The full name and address of all persons and parties interested in the foregoing bids as principals are as follows:

Total Bid Price \$ _____

The contract will be awarded to the best and most responsive bid based on the qualifications of the Contractor and the total price of the Total Bid.

SIGNED

PRESIDENT

COMPANY

SECRETARY

BY

TITLE

DATE

ADDRESS

EXCEPTION SHEET

Exceptions: Exceptions to any bid specification must be clearly stated on this sheet. This sheet must be submitted with each bid. If there are no exceptions, please indicate "none" below.

1) _____

2) _____

3) _____

4) _____

5) _____

6) _____

7) _____

8) _____

9) _____

10) _____

BIDDER IDENTIFICATION

ATTENTION BIDDER:

Please fill out this form and submit with your bid.

COMPANY NAME:

CHIEF EXECUTIVE OFFICER:

ADDRESS:

PHONE NUMBER:

FAX NUMBER:

PROJECT CONTACT PERSON:

PHONE NUMBER:

E-MAIL ADDRESS:

FEDERAL ID #:

WEBSITE ADDRESS:

TABLE OF CONTENTS

- Proposal Price (Bid) Sheet
- Exception Sheet
- Bidder Identification

- A) Invitation to Bidders

- Directions to Warren County Administration Building

- B) General Instructions to Bidders

- C) Affidavit of Non-Collusion

- D) Bid Guaranty & Contract Bond

- E) Performance Bond

- F) Contract

- G) Bond & Insurance Requirements

- H) Experience Statement

- I) Affidavit of Non-Delinquency of Real and/or Personal Property Tax

- J) Non-Discrimination and Equal Employment Opportunity Requirements and Affidavit

- K) Findings for Recovery Affidavit

- L) Wage Rate Determination

- M) Special Provisions/Technical Specifications

SECTION A

INVITATION TO BIDDERS

INVITATION TO BIDDERS

Sealed bids will be received by the Clerk of the County Commissioners, Warren County, Ohio, 406 Justice Drive, Lebanon, Ohio 45036, until 9:30 a.m., August 14, 2024, and then at said time bids will be opened and read aloud for the 2024 Hamilton Road Drilled Pier Wall Project.

Bid documents and specifications are available online at the Warren County's Website at <https://www.co.warren.oh.us/commissioners/Bids/Default.aspx>. Questions regarding the technical specifications should be directed to Logan Smith, Project Engineer, at the Warren County Engineer's Office, at (513) 695-3318. Each bid shall contain the full name of each person or company submitting the bid and be accompanied by a bid bond for the full amount of the bid or a certified check in the amount equal to ten (10) percent of the bid.

Contact the Warren County Commissioner's Office at (513) 695-1250 should you need assistance in accessing the bidding information on the County's website. All contract addenda will be posted to the website prior to the bid opening. Bidders should check the website regularly to stay updated on any changes to the project.

Please be aware that if you are downloading this document to bid this project, and in order to stay updated on any change, please email Jeff Stilgenbauer in the Commissioners' Office at jeffery.stilgenbauer@co.warren.oh.us with your contact information.

A Bid guaranty, as required by Ohio Revised Code, Section 153.54, shall accompany each proposal submitted, as follows:

1. A Certified check, cashier's check, or letter of credit equal to ten (10) percent of the bid. A letter of credit may only be revocable by the Owner. Upon entering into a contract with the Owner, the contractor must file a performance bond for the amount of the contract, and the bid guaranty will then be returned to the successful and unsuccessful bidders upon contract execution.

OR

2. A form of bid guaranty bond (attached) for the full amount of the bid. Such bond is retained for the successful bidder, but returned to unsuccessful bidders after the contract is executed.

Attention of bidders is called to all of the requirements contained in the bid packet. No bidder may withdraw his/her bid within sixty (60) days after the actual date of the opening thereof. All bids shall be properly signed by an authorized representative of the bidder.

All bids shall be sealed and plainly marked "**Bid Opening – 2024 HAMILTON ROAD DRILLED PIER WALL PROJECT, AUGUST 14, 2024 @ 9:30 a.m.**"

Warren County reserves the right to reject any or all bids submitted, to waive any irregularities in bids, and enter into a contract with the Bidder who in Warren County's consideration offered the lowest and best bid.

By order of the Board of County Commissioner, County of Warren, State of Ohio.

Krystal Powell, Clerk



DIRECTIONS FROM INTERSTATE HIGHWAYS 71 & 75 TO WARREN COUNTY, OHIO

COUNTY ADMINISTRATION BUILDING

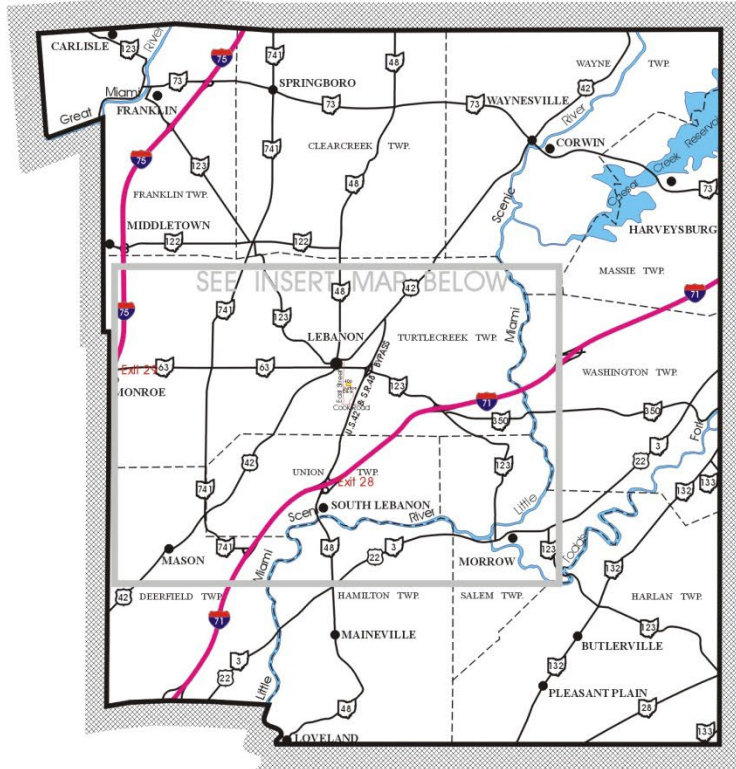

TRI-STATE REGION COUNTIES



- FROM INTERSTATE 75:**
- Take Monroe / Lebanon Exit 29,
 - Head East on S. R. 63 into Lebanon,
 - Turn right onto East Street,
 - Turn left onto Justice Drive,
 - Turn left into parking lot,
 - At first driveway on left.
- FROM INTERSTATE 71:**
- Take Lebanon / South Lebanon Exit 28,
 - Head North on U. S. 42 / S. R. 48 Bypass,
 - Turn left onto Cook Road at traffic light,
 - Turn at first right onto Justice Drive,
 - Turn right at first street on right,
 - Then left into parking lot at first left.

INSERT FROM ABOVE MAP



INSERT FROM MAP AT LEFT

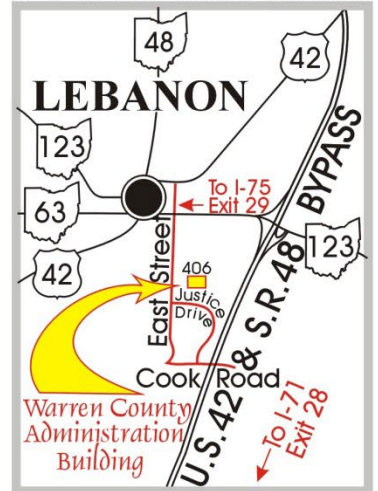

Map Prepared By: Warren County Regional Planning Commission

SECTION B

GENERAL INSTRUCTIONS TO BIDDERS

GENERAL INSTRUCTIONS TO BIDDERS

1. **Receipt and Opening of Bids:** The Warren County Board of Commissioners (herein referred to as "Owner"), invites bids on the form attached hereto, all blanks of which must be appropriately filled in. Bids will be received by the Owner at the Office of the Warren County Board of Commissioners until 9:30 a.m., August 14, 2024, and then at said office publicly opened and read aloud. The envelopes containing the bids must be sealed, addressed to Warren County Board of Commissioners at 406 Justice Drive, Lebanon, Ohio 45036. Bids shall be submitted in a sealed envelope clearly marked "**Bid Opening – 2024 Hamilton Road Drilled Pier Wall Project, August 14, 2024 @ 9:30 a.m.**"

The Owner may consider informal any bid not prepared and submitted in accordance with the provisions hereof and may waive any informalities or reject any and all bids. Any bid may be withdrawn prior to the above scheduled time for the opening of bids or authorized postponement thereof. Any bid received after the time and date specified shall not be considered. No bidder may withdraw a bid within 60 days after the actual date of the opening thereof.

2. **Withdrawal of Bid:** A Bidder may withdraw his bid from consideration if the price bid was substantially lower than the other bids, provided the bid was submitted in good faith and the reason for the price being substantially lower was a clerical mistake as opposed to a judgment mistake and was actually due to an unintentional omission of a substantial quantity of work, labor or material made directly in the compilation of the bid. Request to withdraw such bid must be made in writing and filed with the Owner within two business days after the opening of bids and prior to the acceptance thereof.
3. **Preparation of Bid:** Each bid must be submitted on the prescribed form and such documents as hereunder described. All blank spaces for bid prices must be filled in, in ink or typewritten, in both words and figures, and the foregoing certifications must be fully completed and executed when submitted.
4. **Method of Bidding:** The Owner invites the following bid(s):

2024 HAMILTON ROAD DRILLED PIER WALL PROJECT

Bids shall be submitted at the time and place indicated in the Invitation to Bidder and shall be included in a sealed envelope, marked with the project title and name and address of the bidder and accompanied by the bid security and other required documents.

Bids may be modified or withdrawn by an appropriate document duly executed (in the manner that a bid must be executed) and delivered to the place where bids are to be submitted at any time prior to the opening of bids.

The Owner invites unit price bids for the construction described in the plans and specifications. These unit prices shall be extended by estimated quantities to develop a total price for the project.

If the total price received from the lowest and best bidder exceeds the amount of funds available to finance the contract, the Owner may:

- a. Reject all bids;

- b. Augment the funds available in an amount sufficient to enable award to the lowest and best bidder;
 - c. Reduce the scope of work by eliminating certain items of work to produce a total bid which is within available funds;
 - d. Reduce the scope of work by reducing the quantity of certain items of work to produce a total bid which is within available funds;
 - e. Reduce the scope of work by a combination of adjustments as outlined in "c" and "d" above to produce a total bid which is within available funds.
 - f. The Owner may reject all bids or may award the contract on the base bid or on the base bid combined with additions or deductible alternates as produces a net amount which is within the available funds.
 - g. The Owner may consider informal and may reject any bid not prepared and submitted in accordance with the provisions hereof. The Owner reserves the right to reject all bids, to waive any informalities or irregularities in the bids received, and to accept any bid which is deemed lowest and best.
5. **Qualification of Bidder:** The Owner may make such investigations as he/she deems necessary to determine the ability of the bidder to perform the work, and the bidder shall furnish to the Owner all such information and data for this purpose as the Owner may request. The Owner reserves the right to reject any bid if the evidence submitted by, or investigation of, such bidder fails to satisfy the Owner that such bidder is properly qualified to carry out the obligations of the contract and to complete the work contemplated therein; conditional bids will not be accepted.
6. **Bid Security:** Each bid must be accompanied by cash, certified check of the bidder, letter of credit equal to ten (10) percent of the bid, or a bid bond prepared on the form of bid bond attached hereto, duly executed by the bidder as principal and having as surety thereon a surety company approved by the Owner. (See Invitation to Bidders for required amounts) Such cash, checks or bid bonds will be returned to bidders after the Owner has awarded the bid and has executed the contract, or, if no award has been made within 60 days after the date of the opening of bids, upon demand of the bidder at any time thereafter, so long as he/she has not been notified of the acceptance of his/her bid.
7. **Liquidated Damages for Failure to Enter into Contract:** Submission of a bid shall be a representation by the Contractor that it has fully reviewed and is familiar with the Contract and all contract documents as defined in the contract and will execute the contract if awarded the bid. The successful bidder, upon his/her failure or refusal to execute and deliver the Contract (attached hereto) and required bonds within 10 days after he/she has received notice of the acceptance of his/her bid, shall forfeit to the Owner, as liquidated damages for such failure or refusal, the security deposited with his/her bid.
8. **Time of Completion and Liquidated Damages:** Bidder must agree to commence work on or before a date to be specified in a written "Notice to Proceed" of the Owner and to fully complete the project within 8 weeks after the written Notice to Proceed has been issued. The completion date may be extended in the event of adverse weather conditions. Bidder must agree also to pay as liquidated damage of ODOT CMS 108.07 for each consecutive calendar day thereafter.

9. **NO DAMAGE FOR DELAY:** No payment, compensation or adjustment of any kind shall be made to the contract price for damages incurred by the contractor because of hindrances or delays in the progress of the work from any cause that is not proximately caused by the Owner's action or failure to act. Whether such hindrances or delays are avoidable or unavoidable, the contractor agrees that he or she will make no claim for compensation, damages or mitigation of liquidated damages for any such delays. Examples of delays include (but are in no manner limited to) obtaining all necessary permission from any government agency or any private party, any act or failure to act by any other contractor, subcontractor and/or supplier, all foreseen and unforeseen events and any conditions or acts of God. It is understood and agreed that the contractor assumes all risks of delays in prosecuting or completing the work under the contract that are not proximately caused by the Owner's action or failure to act. The contractor will accept in full satisfaction for such delays, an extension of time, if any, agreed to by the Owner.
10. **Conditions of Work:** Each bidder must inform him/herself fully of the conditions relating to the construction of the project and the employment of labor thereon. Failure to do so will not relieve a successful bidder of his/her obligation to furnish all material and labor necessary to carry out the provisions of his/her contract. Insofar as possible the contractor, in carrying out the work, must employ such methods or means or will not cause any interruption of or interference with the work of any other contractor.
11. **Addenda and Interpretations:** No interpretation of the meaning of the plans, specifications or other pre-bid documents will be made to any bidder orally. Every request for such interpretation must be in writing and addressed to: Logan Smith, Warren County Engineer's Office, 210 West Main Street, Lebanon, Ohio, 45036, and to be given consideration must be received at least five days prior to the date fixed for the opening of bids. All such interpretations and any supplemental instructions will be in the form of written addenda to the specifications which, if issued, will be mailed by certified mail with return receipt requested to all prospective bidders (at the respective addresses furnished for such purposes), no later than three days prior to the date fixed for the opening of bids. Failure of any bidder to receive any such addendum or interpretations shall not relieve such bidder from any obligation under his/her bid as submitted. All addenda so issued shall become part of the contract documents.
12. **Security for Faithful Performance:** Simultaneously with the delivery of the executed Contract, the Contractor shall furnish payment and performance bonds as security for faithful performance of this contract and for the payment of all subcontracts, suppliers and laborers performing labor on the project under the Contract and furnishing materials in connection with the Contract.
- The surety on such bond or bonds shall be a duly authorized surety company satisfactory to the Owner. Please note that upon execution of the Contract if a Bid Guaranty/Contract Bond was submitted with your original bid a Performance Bond will not be required.
13. **Power of Attorney:** Attorneys-in-fact who sign bid bonds or contract bonds must file with each bond a certified and effectively dated copy of their power of attorney.
14. **Laws and Regulations:** The bidder's attention is directed to the fact that all applicable State laws, municipal ordinances, and the rules and regulations of all authorities having jurisdiction over construction of the project shall apply to the contract throughout, and they will be deemed to be included in the contract the same as though herein written out in full.

15. **Method of Award - Lowest Qualified Bidder:** The Owner may reject all bids or may award the contract on the base bid or on the base bid combined with additions or deductible alternates as produces a net amount which is within the available funds.
16. **Obligation of Bidder:** At the time of the opening of bids each bidder will be presumed to have inspected the site and to have read and to be thoroughly familiar with the plans and contract documents (including all addenda). The failure or omission of any bidder to examine any form, instrument or document shall in no way relieve any bidder from any obligation in respect of his/her bid.
17. **Safety Standards and Accident Prevention:** With respect to all work performed under this contract, the Contractor shall:
 - a. Comply with the safety standards provisions of applicable laws, building and construction codes and the "Manual of Accident Prevention in Construction" published by the Associated General Contractors of America, the requirements of the Occupational Safety and Health Act of 1970 (Public Law 91-596), and the requirements of title 29 of the code of Federal Regulations, Section 1518 as published in the "Federal Register", Volume 36, N. 75, Saturday, April 17, 1971.
 - b. Exercise every precaution at all times for the prevention of accidents and the protection of persons (including employees) and property.
 - c. Maintain at his/her office or other well-known place at the job site, all articles necessary for giving first aid to the injured, and shall make standing arrangements for the immediate removal to a hospital or doctor's care of persons (including employees) who may be injured at the job site. In no case shall employees be permitted to work at a job site before the employer has made a standing arrangement for removal of injured persons to a hospital or a doctor's care.
18. **Examination of Site:** Each bidder shall, and is hereby directed to inspect the entire site of the proposed work and judge for him/herself as to all the circumstances affecting the cost and progress of the work and shall assume all patent and latent risks in connection therewith.
19. **Soil Conditions:** Subject to the convenience of the Owner, prospective bidders will be permitted to explore the site by making borings or digging test pits. In such event, the work shall be done at the sole expense and risk of the bidder, and he/she shall maintain and restore the site to original condition. The Owner does not guarantee the accuracy of any information or samples which it may have obtained from test borings or otherwise as to the kind or condition of the soil that may be encountered in the prosecution of the proposed work, neither does the Owner represent that the plans and specifications drawn are based upon any data so obtained. The Owner does not make any representation as to the soil which may be encountered or of soil or water which underlies the work or is adjacent thereto, including any difficulties that may be due to quicksand, or other unfavorable conditions that may be encountered in the work, whether apparent upon surface inspection or disclosed in the process of carrying forward the work.
20. **Water Supply:** All water for construction purposes, as well as the expense of having water conveyed about the work, must be provided by the Contractor and the cost of this work shall be included in the unit prices stipulated for the various items of the work to be done under this contract.

21. **Working Facilities:** The plans show, in the general manner, the existing structures and the land available for construction purposes. The bidders must satisfy themselves of the conditions and difficulties that may be encountered in the execution of the work at this site.
22. **Permits:** The Contractor shall take out all necessary permits from the proper authorities, and shall give all notices required by law or ordinance. The charge or fee for any permit issued by the proper authority shall be borne by the contractor.
23. **Signature of Bidders:** The firm, corporate or individual name of the bidder must be signed in ink in the space provided for the signatures on the proposed blanks. In the case of a corporation, the title of the officer signing must be stated and such officer must be thereunto duly authorized and the seal of said corporation duly affixed. In the case of a partnership, the signature of at least one of the partners must follow the firm name, using the term "member of the firm." In the case of an individual, use the terms "doing business as", or "sole owner." The bidder shall further state in his/her proposal the name and address of each person or corporation interested therein.
24. **Right to Accept or Reject Proposals:** The Owner may consider informal and may reject any bid not prepared and submitted in accordance with the provisions hereof. The Owner reserves the right to reject all bids, to waive any informalities or irregularities in the bids received, and to accept any bid which is deemed lowest and best.
25. **Non-Collusion Affidavit:** The successful bidder will be required to submit a non-collusion affidavit on the form included in these Bid/Contract documents (Section C). This affidavit shall be dated and executed as part of this bid.
26. **EEO Compliance:** Bidders please see Section J for EEO Compliance Requirements and Affidavit.
27. **Prevailing Wage Rates:** This Project is subject to Prevailing Wage Requirements. In the event that the rate of wages paid for any trade or occupant in the locality where such work is being performed are under current collective agreements or understandings between bona fide organizations of labor and employer, then the wages to be paid shall be not less than such agreed wage rates, nor less than the minimum rates compiled by the Federal Labor Standard Act. A copy of these prevailing wage rates has been included in these specifications as Exhibit L. Every Contractor and Subcontractor who is subject to Ohio Revised Code, Chapter 4115 shall, as soon as he/she begins performance under his/her contract with the Owner, supply the Prevailing Wage Coordinator for the Owner a schedule of the dates on which he/she is required to pay wages to employees. He/ She shall also deliver to the Prevailing Wage Coordinator within three weeks after each pay date, a certified copy of his/her payroll which shall exhibit for each employee paid any wages, name, current address, social security number, number of hours worked each day of the pay period and the total for each week, hourly rate of pay, job classification, fringe payments, and deductions from wages. The certification of each payroll shall be executed by the Contractor, Subcontractor, or duly appointed agent thereof and shall recite that the payroll is correct and complete and that the wage rate shown is not less than those required by the contract.

In case the Owner orders the Contractor to perform extra or additional work which may make it necessary for the Contractor or any Subcontractor under this contract to employ a person not herein specified, the Owner will include in the contract change order for such extra or additional work, a minimum wage rate for such trade or occupation, and insofar as such extra or additional work is concerned, there shall be paid to each employee engaged in work of such

trade or occupation, not less than the wage so included. Insofar as possible, local labor shall be employed on this work.

28. **Subletting of Contract:** The Contractor shall not sublet, sell, transfer or assign any portion of the contract without written consent of the Owner or his/her designated agent. When such consent is given, the Contractor will be permitted to sublet a portion thereof, but shall perform with his/her own organization, work amounting to no less than fifty percent of the total contract cost, except that any time designated in the contract before computing the amount of work required to be performed by the Contractor with his/her own organization, No subcontract, or transfer of contract, shall in any way release the Contractor of his/her liability under the contract and bonds.
29. **Required Insurance:** In accordance with the specifications, the Contractor, without restricting the obligations and liabilities assumed under the Contract Documents, shall at his/her own cost and expense purchase and maintaining in force until final acceptance of his/her work, the forms of insurance coverage listed below.

Certificates from the insurance carrier stating the limits of liability and expiration date shall be filed with the Owner before operations are begun. Such certificates shall not merely name the types of policy provided, **but shall specifically refer to this Contract** and shall name the Board of Warren County Commissioners as additionally insured. However, the original policy for Owner's Protective Bodily Injury (Item D) and Property Damages (Item E) shall at this time be delivered to the Owner for its possession.

All policies as hereinafter required shall be so written that the Owner will be notified of cancellation or restrictive amendment at least ten days prior to the effective date of such cancellation or amendment.

Item A - Workmen's Compensation and/or Employer's liability Insurance as required or specified by State Law.

Item B – Comprehensive General Liability Insurance: In an amount not less than \$1,000,000.00 per occurrence for Bodily Injury and \$500,000 for explosion underground and collapse, commonly known as “XCU.” The following endorsement documents provided by Warren County:

- a. CG 20 10 10 01 – additional insured endorsement (or equivalent)
- b. CG 20 37 10 01 – additional insured endorsement (or equivalent)
- c. CG 25 03 03 97 – designated location aggregate (or equivalent)

General Liability needs to be written on Primary/Non-contributory basis for the benefit of the additional insured.

Item C – Umbrella: In an amount not less than \$1,000,000 occurrence and \$1,000,000 aggregate. Umbrella needs to attach to General Liability, Employers Liability, Auto Liability. Umbrella needs to be written on follow-form primary.

Item D - Bodily Injury Liability Insurance covering motor vehicles either owned by the Contractor or being used in connection with the prosecution of the work embraced under this contract.

Item E - Property Damage Liability Insurance covering motor vehicles either owned by the Contractor or being used in connection with the prosecution of the work embraced under this contract.

Item F - (If Applicable) - Such Protective (including Railroad Protective) and Contractual Bodily Injury Liability Insurance and such Protective (including Railroad Protective) and Contractual Property Damage Liability Insurance as shall be required by the railroad and other utility companies whose property, facilities or rights-of-way may be affected by the work to be done under this contract, in such amounts and in such form as each such utility company may require.

If any part of the work is sublet, insurance of the same types and limits as required by above items numbered A, B, C, D, E, and F shall be provided by or on behalf of the Subcontractors to cover that part of the work they have contracted to perform including Property Damage Liability Special Hazards coverage if so required by this contract.

Protective and Contractual Bodily Injury Liability Insurance required by Item F (if applicable) shall be in an amount and form as each railroad or utility company may require.

Builders Risk Insurance: All Risk form, including subsidence and theft of materials from the job site. Such coverage shall be maintained until final acceptance of the Contract by the Owner and payable to the Owner for the benefit of the contractor. The limit for Builders Risk shall be the full value of construction. (Sample form at end of this section)

30. **Maintenance of Rights-Of-Way:** All construction as proposed along all City, Township, County, State and Federal roads including storage and stockpiling of materials, is to be conducted within the limits of the public right-of-way. Bracing sheeting and shoring shall be used to keep all construction work within the construction limits unless work agreements are secured from the adjacent property Owners. It is the Contractor's responsibility to secure these work agreements, if deemed necessary. Copies of the work agreements shall be delivered to the Engineer and Owner prior to any work beginning on the affected property.
31. **Lights, Signs and Barricades:** Lights, signs and barricades shall be used to maintain traffic and safety for vehicular and pedestrian traffic during the course of this contract and shall be the sole responsibility of the Contractor.
32. **Foreign Corporation and Contractors:**

Foreign Corporations

Definition: "Foreign Corporation" means a corporation incorporated under the laws of another state. No contract shall be entered into with a foreign corporation until the Secretary of State has certified that such corporation is authorized to do business in Ohio: and until, if the bidder so awarded the Contract is a person or partnership, it has filed with the Secretary of State a Power of Attorney designating the Secretary of State as its agent for the purpose of accepting service of summons in any action brought under Ohio Revised Code, Section 153.05 or under Sections 4123.01 to 4123.94, inclusive.

33. **Subcontracts:** Contractor shall provide an explanation as part of its bid package of all subcontractors intended to be used in performance of the work described in Part II, Section

D. In the event the Owner does not object, Contractor may have such work performed by a subcontractor. Contractor shall bind every subcontractor to, and every subcontractor must agree to be bound by the terms of, the Contract, as far as applicable to the subcontractor's work particularly pertaining to Prevailing Wages and EEO requirements. Nothing contained in the Agreement shall create any contractual relationship between any subcontractors and Owner, nor create any obligations on the part of the Owner to pay or see to the payment of any sums to any subcontractor.

34. **Real and/or Personal Property Tax Affidavit:** All bidders must complete the Real and/or Personal property tax affidavit (Section I) and submit with your bid. ***This section should be fully completed whether or not you as a vendor/contractor own property in Warren County, Ohio.***
35. **Description of Project:**

See Section M
36. **Scope of Work:** Provide all work as required by Contract and described in the Specifications herein (Section M) as necessary to provide for project completion.
37. **Required Forms:** Each Bidder shall complete and submit the following forms with his/her bid:
Proposal Price (Bid) Sheet
Exception Sheet
Bidder Identification
Non-Collusion Affidavit
Bid Guaranty & Contract Bond
Experience Statement
Affidavit of Non-Delinquency of Taxes
Certificate of Compliance Non-Discrimination and Equal Employment Opportunity Affidavit
Findings for Recovery Affidavit
38. The successful Contractor may be required, at the request of the Owner, to submit a list of sub-contractors and suppliers for said project.
39. **Additional Obligations Upon Contract Award:** Upon award of the bid but prior to execution of the Contract and Notice to Proceed, the Contractor shall submit all of the following documents, completed as required:
 - 1) Contract
 - 2) Required Bonds
 - 3) Payment Draw Schedule (Required for Projects of \$500,000 or more)
 - 4) Certificates of Insurance
40. ***Entire bid packet must be completed (except contract – Section F) and returned with bid proposal, as the entire bid packet becomes part of the contract documents.***
41. **STATEMENT: Do not submit confidential documents or documents of any type that contain trade secrets. All materials submitted become public records once opened and may be copied upon request to anybody including competitive bidders.**

SECTION C

AFFIDAVIT OF NON-COLLUSION

AFFIDAVIT OF NONCOLLUSION

STATE OF _____
COUNTY OF _____

I, _____, holding the title and position of _____ at the firm _____, affirm that I am authorized to speak on behalf of the company, board directors and owners in setting the price on the bid or proposal. I understand that any misstatements in the following information will be treated as fraudulent concealment of true facts on the submission of the bid or proposal.

I hereby swear and depose that the following statements are true and factual to the best of my knowledge:

The bid/proposal is genuine and not made on the behalf of any other person, company or client, INCLUDING ANY MEMBER OF THE WARREN COUNTY BOARD OF COMMISSIONERS.

The price of the bid/proposal was determined independent of outside consultation and was not influenced by other companies, clients or contractors, INCLUDING ANY MEMBER OF THE WARREN COUNTY BOARD OF COMMISSIONERS.

No companies, clients or contractors, INCLUDING ANY MEMBER OF THE WARREN COUNTY BOARD OF COMMISSIONERS have been solicited to propose a fake bid/proposal for comparative purposes.

No companies, clients or contractors, INCLUDING ANY MEMBER OF THE WARREN COUNTY BOARD OF COMMISSIONERS have been solicited to refrain from bidding or to submit any form of noncompetitive bidding.

The price of the bid/proposal has not been disclosed to any client, company or contractor, INCLUDING ANY MEMBER OF THE WARREN COUNTY BOARD OF COMMISSIONERS, and will not be disclosed until the formal date on _____

AFFIANT

Subscribed and sworn to before me this ____ day of _____ 20 ____

(Notary Public),

_____ County.

My commission expires _____ 20 ____

SECTION D

BID GUARANTY AND CONTRACT BOND

BID GUARANTY AND CONTRACT BOND

KNOW ALL MEN BY THESE PRESENTS, that we, the undersigned,

(Insert full name or legal title of Contractor and Address)

as _____ Principal _____ and

(Insert full name or legal title of Surety)

as Surety, are hereby held and firmly bound unto the Warren County Board of Commissioners hereinafter called the Oblige, in the penal sum of the dollar amount of the bid submitted by the Principal to the Oblige on _____ to undertake the project known as:

2024 HAMILTON ROAD DRILLED PIER WALL PROJECT

The penal sum referred to herein shall be the dollar amount of the Principal's bid to the Oblige, incorporating any additive or deductive alternate proposals made by the Principal on the date referred to above to the Oblige, which are accepted by the Oblige, In no case shall the penal sum exceed the amount of _____ DOLLARS, \$ _____.

If this item is left blank, the penal sum will be the full amount of the Principal's bid, including alternates. Alternatively, if completed, the amount stated must not be less than the full amount of the bid, including alternates in dollars and cents. A percentage is not acceptable.

For the payment of the penal sum well and truly to be made we hereby jointly and severally bind ourselves, our heirs, executors, administrators, successors, and assigns.

THE CONDITION OF THE ABOVE OBLIGATION IS SUCH that whereas the above named Principal has submitted a bid on the above referred to project;

NOW, THEREFORE, if the Oblige accepts the bid of the Principal and the Principal fails to enter into a proper contract in accordance with the bid, plans, details, specifications, and bills of material; and in the event the Principal pays to the Oblige the difference not to exceed ten percent of the penalty hereof between the amount specified in the bid and such larger amount for which the Oblige may in good faith contract with the next lowest bidder to perform the work covered by the bid; or in the event the Oblige does not award the contract to the next lowest bidder and resubmits the project for bidding, the Principal will pay the Oblige the difference not to exceed ten percent of the penalty hereof between the amount specified in the bid, or the costs, in connection with the resubmission, of printing new contract documents, required advertising, and printing and mailing notices to prospective bidders, whichever is less, then this obligation shall be null and void, otherwise to remain in full force and effect. If the Oblige accepts the bid of the Principal and within TEN days after the awarding of the contract, enters into a proper contract in accordance with the bid, plans, details, specifications, and bills of material, which said contract is made a part of this bond the same as though set forth herein; and

IF THE SAID PRINCIPAL SHALL well and faithfully perform each and every condition of such contract; and indemnify the Oblige against all damage suffered by failure to perform such contract according to the provisions thereof and in accordance with the plans, details, specifications, and bills of material therefore; and shall pay all lawful claims of subcontractors, materialmen, and laborers, for labor performed and materials furnished in the carrying forward, performing, or completing of said contract: we agreeing and assenting that this undertaking shall be for benefit of any materialman or laborer having a just claim, as well as for the Oblige herein; **THEN THIS OBLIGATION SHALL**

be void; otherwise the same shall remain in full force and effect; it being expressly understood and agreed that the liability of the Surety for any and all claims hereunder shall in no event exceed the penal amount of this obligation as herein stated.

THE SAID surety hereby stipulates and agrees that no modifications, omissions, or additions, in or to the terms of said contract or in or to the plans and specifications therefor shall in any wise affect the obligations of said surety on its bond, and it does hereby waive notice of any such modifications, omissions or additions to the terms of the contract or to the work or to the specifications.

SIGNED AND SEALED this _____ day of _____ 2024.

PRINCIPAL

SURETY

By: _____

By: _____

Attorney-in-fact

Title: _____

Surety Agent's Name and Address:

SECTION E
PERFORMANCE BOND

PERFORMANCE BOND

KNOW ALL MEN BY THESE PRESENTS: that

(Name of Contractor)

(Address of Contractor)

a _____, hereinafter called
(Corporation, Partnership or Individual)

Principal, and

(Name of Surety)

(Address of Surety)

hereinafter called Surety, are held and firmly bound unto

WARREN COUNTY, OHIO BOARD OF COMMISSIONERS
406 Justice Drive
Lebanon, OH 45036

hereinafter called OWNER, in the penal sum of _____ Dollars,
\$(_____) in lawful money of the United States, for the payment of which sum well and
truly to be made, we bind ourselves, successors, and assigns, jointly and severally, firmly by these
presents.

THE CONDITION OF THIS OBLIGATION is such that whereas, the Principal entered into a
certain contract with the OWNER, dated the _____ day of _____, 2024, a copy of
which is hereto attached and made a part hereof for the construction of:

NOW, THEREFORE, if the Principal shall well, truly and faithfully perform its duties, all the undertakings, covenants, terms, conditions, and agreements of said contract during the original term thereof, and any extensions thereof which may be granted by the OWNER, with or without notice to the Surety and during the guaranty period(s), and if he/she shall satisfy all claims and demands incurred under such contract, and shall fully indemnify and save harmless the OWNER from all costs and damages which it may suffer by reason of failure to do so, and shall reimburse and repay the OWNER all outlay and expense which the OWNER may incur in making good any default, then this obligation shall be void; otherwise to remain in full force and effect.

PROVIDED, FURTHER, that the said surety, for value received, hereby stipulates and agrees that no change, extension of time, alteration or addition of the terms of the contract or the WORK to be performed thereunder or the SPECIFICATIONS accompanying the same shall in any way affect its obligation on this BOND, and it does hereby waive notice of any such change, extension of time, alteration or addition to the terms of the contract or to the WORK or to the SPECIFICATIONS.

PROVIDED, FURTHER, that no final settlement between the OWNER and the CONTRACTOR shall abridge the right of any beneficiary hereunder, whose claim may be unsatisfied.

IN WITNESS WHEREOF, this instrument is executed in counterparts, each one of which shall be deemed an original, this the _____ day of _____ 2024.

ATTEST:

(Principal)

(SEAL)

By _____

ATTEST:

(SEAL)

(Surety)

IMPORTANT: Pursuant to Ohio Revised Code §122.87(A) a surety company is defined as, “. . . a company that is authorized by the department of insurance to issue bonds as a surety”.

SECTION F

CONTRACT

CONTRACT

THIS AGREEMENT, made this _____ day of _____, 2024, with the Warren County Board of Commissioners, 406 Justice Drive, Lebanon, Ohio hereinafter called "Owner" and **VENDOR NAME AND ADDRESS**, doing businesses as (an individual, partner, a corporation) hereinafter called "Contractor."

WITNESSETH: That for and in consideration of the payments and agreements hereinafter mentioned, to be made and performed by the Owner, the Contractor hereby agrees with the Owner to commence and complete the construction described as follows:

2024 HAMILTON ROAD DRILLED PIER WALL PROJECT

hereinafter called the project, for the sum of **\$AMOUNT (AMOUNT WRITTEN OUT)**, and all work in connection therewith, under the terms as stated in the Conditions of the Contract; and as his/her (its or their) own proper cost and expense furnish all the materials, supplies, machinery, equipment, tools, superintendence, labor insurance, and other accessories and services necessary to complete the said project in accordance with the conditions and prices stated in the Proposal, Conditions of the Contract, the Specifications and Contract Documents. "Contract Documents" means and includes the following:

- Proposal Price (Bid) Sheet
- Exception Sheet
- Bidder Identification
- A) Invitation to Bidders
- B) General Instruction to Bidders
- C) Non-Collusion Affidavit
- D) Bid Guaranty & Contract Bond
- E) Performance Bond
- F) Contract
- G) Bonding & Insurance Requirements
- H) Experience Statement
- I) Affidavit of Non-Delinquency of Real and/or Personal Property Tax
- J) Equal Employment Opportunity Requirements, Bid Conditions and Non-discrimination and Equal Employment Opportunity Affidavit
- K) Findings for Recovery Affidavit Wage Rate Determination
- L) Wage Rate Determination
- M) Special Provision/Technical Specifications

The CONTRACTOR hereby agrees to commence work under this contract on or before a date to be specified in a Written "Notice to Proceed" of the OWNER, and to fully complete the project by 8 weeks after written notice-to-proceed has been issued and preconstruction meeting has been held. The Contractor further agrees to pay, as liquidated damages, the sum of \$300.00 for each consecutive calendar day thereafter.

This Agreement may be terminated by either party upon written notice in the event of substantial failure by the other party to perform in accordance with the terms of this Agreement. The nonperforming party shall have fifteen calendar days from the date of the termination notice to cure or to submit a plan for cure acceptable to the other party.

OWNER may terminate or suspend performance of this Agreement for OWNER'S convenience upon a written notice to CONTRACTOR. CONTRACTOR shall terminate or suspend performance of the services/work on a schedule acceptable to OWNER.

The CONTRACTOR will indemnify and save the OWNER, their officers and employees, harmless from loss, expenses, costs, reasonable attorney's fees, litigation expenses, suits at law or in equity, causes of action, actions, damages, and obligations arising from (a) negligent, reckless or willful and wanton acts, errors or omissions by CONTRACTOR, its agents, employees, licensees, consultants or subconsultants; (b) the failure of the CONTRACTOR, its agents, employees, licensees, consultants or subconsultants to observe the applicable standard of care providing services pursuant to this agreement; (c) the intentional misconduct of the CONTRACTOR, its agents, employees, licensees, consultants or subconsultants that result in injury to persons or damage to property for which the OWNER may be held legally liable.

The CONTRACTOR does hereby agree to indemnify and hold the OWNER harmless for any and all sums for which the OWNER may be required to pay or for which the OWNER may be held responsible for failure of the CONTRACTOR or any subcontractor to pay the prevailing wage upon this project.

The OWNER agrees to pay the CONTRACTOR in the manner and at such times as set forth in the General Provisions such amounts as required by the Contract Documents.

This Agreement shall be binding upon all parties hereto and their respective heirs, executors, administrators, successors, and assigns.

Contractor shall bind every subcontractor to, and every subcontractor must agree to be bound by the terms of, this Agreement, as far as applicable to the subcontractor's work particularly pertaining to Prevailing Wages and EEO requirements. Nothing contained in this Agreement shall create any contractual relationship between any subcontractor and Owner, nor create any obligations on the part of the Owner to pay or see to the payment of any sums to any subcontractor.

IN WITNESS WHEREOF, the parties hereto have executed, or caused to be executed by their duly authorized officials, this Agreement in two counterparts, each of which shall be deemed an original on the date first above written.

WARREN COUNTY BOARD OF COMMISSIONERS
(Owner)

David G. Young, President

Vendor Name

By:

Name

Title

Approved as to Form:

Assistant Prosecutor

SECTION G

BONDING AND INSURANCE REQUIREMENTS

BONDING AND INSURANCE REQUIREMENTS

A state or local unit of government receiving a grant from the federal government which requires contracting for construction of facility improvement shall follow its own requirements relating to bid guarantees, performance bonds, and payment bonds, except for contracts or subcontracts exceeding \$100,000. For contracts or subcontracts exceeding \$100,000, the Federal agency may accept the bonding policy and requirements of the grantee provided the Federal agency has made a determination that the Government's interest is adequately protected. If such a determination has not been made, the minimum requirements shall be as follows:

- a. **A bid guaranty from each bidder.** The "bid guaranty" shall consist of a firm commitment such as a bid bond in the amount of one hundred (100) percent of the bid price, or ten (10) percent of the bid price if certified check or other negotiable instrument accompanying a bid, as assurance the bidder will, upon acceptance of his/her bid, execute such contractual documents as may be required within the time specified.

- b. **A performance bond on the part of the Contractor for 100 percent of the contract price.** A "performance bond" is one executed in connection with a contract to secure fulfillment of all the contractor's obligations under such contract.

SECTION H

EXPERIENCE STATEMENT

SECTION I

***AFFIDAVIT OF NON-DELINQUENCY OF REAL
AND/OR PERSONAL PROPERTY TAX***

SECTION J

***EQUAL EMPLOYMENT OPPORTUNITY REQUIREMENTS,
BID CONDITIONS AND
NON-DISCRIMINATION AND EQUAL
EMPLOYMENT OPPORTUNITY AFFIDAVIT***

**EQUAL EMPLOYMENT OPPORTUNITY REQUIREMENTS
AND BID CONDITIONS FOR
WARREN COUNTY CONSTRUCTION PROJECTS**

CERTIFICATE OF COMPLIANCE FOR EEO PURPOSES: (This section applies only to projects that are funded with Federal and State monies)

All bidders on the project **shall** submit together with their bid, a copy of a valid Certificate of Compliance for Equal Employment Opportunity purposes contained herein.

A copy of the Certificate of Compliance is enclosed with this bid response? Yes No

BIDDER'S EEO COVENANTS:

Throughout its performance of any contract awarded to it on this project, the bidder agrees to the following covenants:

1. The contractor will not discriminate against any employee or applicant for employment because of race, color, religion, national origin, ancestry or sex. The contractor will take affirmative action to ensure that applicants are employed, and that employees are treated during employment without regard to their race, color, religion, national origin, ancestry or sex. Such action shall include, but is not limited to, the following: Employment, upgrading, demotion, or transfer; recruitment or recruitment advertising; layoff or termination; rates of pay or other forms of compensation; and selection for training, including apprenticeship. The contractor agrees to post in conspicuous places, available to employees and applicants for employment, notices to be provided setting forth the provisions of this nondiscrimination clause.
2. The contractor will in all solicitations or advertisements for employees placed by or on behalf of the prime contractor, state that all qualified applicants will receive consideration for employment without regard to race, color, religion, national origin, ancestry or sex.
3. The contractor agrees to fully cooperate with the County, the State Equal Employment Opportunity Coordinator and with any other official or agency, or the State or Federal government which seeks to eliminate unlawful employment discrimination, and with all other State and Federal efforts to assure equal employment practices under its contract and the contractor shall comply promptly with all requests and directions from the County, the State Equal Opportunity Coordinator and any of the State of Ohio officials and agencies in this regard, both before and during construction.
4. Full cooperation as expressed in clause (3), above, shall include, but not be limited to, being a witness and permitting employees to be witnesses and complainants in any proceedings involving questions of unlawful employment practices, furnishing all information requested by the County and the State Equal Employment Opportunity Coordinator, and permitting access to its books, records, and accounts by the County and the State Equal Employment Opportunity Coordinator for purposes of investigation to ascertain compliance with applicable rules, regulations and orders.

5. In the event of the contractor's noncompliance with the nondiscrimination clauses of its contract or with any of the said rules, regulations, or orders, its contract may be canceled, terminated, or suspended in whole or in part and the contractor may be declared ineligible for further County construction contracts.

In the event that is contract is terminated for a material breach of EEO requirements, the contractor shall become liable for any and all damages which shall accrue to the County as a result of said breach.

6. The contractor will require the inclusion of language reflecting these same six covenants within every subcontract or purchase order it executes in the performance of its contract unless exempted by rules, regulations or orders of the State Equal Employment Opportunity Coordinator so that these provisions will be binding upon each subcontractor or vendor. The contractor will take such as the County may direct as a means of enforcing such provisions, including sanctions for noncompliance; provided, however, that in any litigation with a subcontractor, vendor or other party as a result of such direction by the County, the contractor may be requested to protect the interests of the County.

The bidder hereby adopts the foregoing covenants?

_____ Yes _____ No

PLEASE NOTE: *The bidder's failure to adopt the Bidder's EEO Covenants and complete the foregoing certification will cause the bidder's proposal to be rejected as being non-responsive.*

SECTION K

FINDINGS FOR RECOVERY AFFIDAVIT

FINDINGS FOR RECOVERY AFFIDAVIT

STATE OF _____
COUNTY OF _____, SS:

_____, upon being duly cautioned and sworn, hereby states the following based on personal knowledge:

- 1) That he/she is _____ (title), of _____ (name of bidder) and authorized to execute this affidavit; and,
- 2) That _____ (name of bidder) is not a person or entity against whom a finding for recovery has been issued by the Auditor of State, which finding for recovery is unresolved as defined in Ohio Revised Code [General Provisions] Section 9.24 (B); and,
- 3) That _____ (name of bidder) does not appear in the database of unresolved findings of recovery maintained by the Auditor of State pursuant to Ohio Revised Code [General Provisions] Section 9.24 (D).

Affiant

Sworn to and subscribed in my presence this _____ day of _____, 2024.

Notary Public
My Commission expires: _____

INSERT WAGE RATE DETERMINATION HERE



Mike DeWine
Governor

Sheryl Maxfield
Director

PREVAILING WAGE GUIDE

WARREN COUNTY

OHIO DEPARTMENT OF COMMERCE

Division of Industrial Compliance
Bureau of Wage and Hour Administration
6606 Tussing Road, PO Box 4009
Reynoldsburg, Ohio 43068-9009
Phone: 614-644-2239
Fax: 614-728-8639
www.com.ohio.gov
TTY/TDD: 1-800-750-0750

The Ohio Department of Commerce is an Equal Opportunity Employer and Service Provider

This packet of information is provided as a summary of the Prevailing Wage guidelines and responsibilities. The Ohio Revised Code, Chapter 4115 should be referred to for the exact wording of the law. Also included are references and forms which should be helpful in the compliance of the Prevailing Wage Law.

PACKET INFORMATION INDEX

A. The Ohio Department of Commerce-Division of Industrial Compliance, Wage and Hour Administration Investigators and their assigned counties

1. The Wage and Hour Investigators for the State of Ohio are listed with their contact information.
 - a. If you have questions or need assistance pertaining to Prevailing Wage, you can contact the Investigator in your area.

B. Prevailing Wage Guide for Public Authorities

1. Notice of change of the Prevailing Wage Threshold Level.
 - a. A notification will be sent to you when there is a change of the Prevailing Wage threshold level
2. Outline of the Public Authority's responsibilities for Prevailing Wage.
3. Public Authority's Compliance Checklist form.
 - a. A form for tracking the progress of a Prevailing Wage project
4. Request form for Prevailing Wage Rates.
 - a. Prevailing Wage Rates can be obtained on the website www.com.ohio.gov
 - (1) Prevailing Wage Determination Schedule of wages must be attached to and made part of the specifications for the project, and must be printed on the bidding blanks where the work is done by contract.
5. Bid Tabulation form
 - a. A form to be completed and returned to ODOC-DIC-Bureau of Wage and Hour Administration when the contract has been awarded.
6. Prevailing Wage Bonds form
 - a. Information needed to be kept on file by the Prevailing Wage Coordinator when bonds from the Public Authority are used for a project.

C. Prevailing Wage Guidelines for the Public Authority's Coordinator

1. Guideline for the Prevailing Wage Coordinator
 - a. The Prevailing Wage complaint form and instructions can be obtained on the website www.com.ohio.gov
2. Record of the Certified Payroll Reports Received form
 - a. Helpful form for recording the Certified Payroll Reports and the dates received from the contractors and subcontractors.
3. Employee Interview form
 - a. Helpful form for the use by the Prevailing Wage Coordinator when making on-site visits.
4. Employee vs. Independent Contractor
 - a. Helpful questions when determining if a person is an Employee or an Independent Contractor.

D. Prevailing Wage Guide for Contractors

(Incorporate this section in the Specifications or supply copies for the pre-construction meeting.)

1. Outline of responsibilities for the Prevailing Wage Contractor
2. Notification form from the Contractor to the Employee
 - a. The contractor must submit to employees a completed and signed notification form.
 - b. Some Prevailing Wage Coordinators may require a copy of the completed Notification to the Employee form be submitted with the Certified Payroll Reports.
3. Certified Payroll Report form
 - a. The contractor can use any form/format he chooses as long as **ALL** the information has been provided.
4. Certified Payroll Report form instruction sheet
5. Corrected Certified Payroll Report Example
6. Affidavit of Compliance form
 - a. No Public Authority shall make final payment unless the **Final Affidavits** have been filed by the contractors and subcontractors.



Mike DeWine
Governor

Sheryl Maxfield
Director

INVESTIGATORS CONTACT INFORMATION

OHIO DEPARTMENT OF COMMERCE

Division of Industrial Compliance
Bureau of Wage and Hour Administration
6606 Tussing Road, PO Box 4009
Reynoldsburg, Ohio 43068-9009
Phone: 614-644-2239
Fax: 614-728-8639
www.com.ohio.gov
TTY/TDD: 1-800-750-0750

The Ohio Department of Commerce is an Equal Opportunity Employer and Service Provider

OHIO DEPARTMENT OF COMMERCE
 Division of Industrial Compliance
 Bureau of Wage and Hour Administration
 Chief, Stephen Clegg

6606 Tussing Road, PO Box 4009
 Reynoldsburg, Ohio 43068-9009
 614-644-2239
 fax: 614-728-8639
<http://www.com.ohio.gov>

INVESTIGATORS and THEIR HEADQUARTER COUNTY

<p>#48 Dave Horvath PO Box 1512 Lima, Ohio 45802-1512 Voice: (419) 302-1200 Fax: (614) 728-8639 Dave.Horvath@com.state.oh.us</p>	<p>Allen *</p>
<p>#30 Mike McKee P.O. Box 1342 Cambridge, Ohio 43725-2247 Voice/Fax: (740) 432-1987 Michael.McKee@com.state.oh.us</p>	<p>Guernsey*</p>
<p>#56 Shawn Miles P.O. Box 2547 North Canton, Ohio 44720 Voice/Fax: (614) 496-9076 Shawn.Miles@com.state.oh.us</p>	<p>Stark *</p>
<p>#37 David Rice P.O. Box 41241 Dayton, Ohio 45441 Voice: (740) 502-0883 Fax: (614) 995-7768 Dave.Rice@com.state.oh.us</p>	<p>Montgomery *</p>
<p>#35 Sean Seibert P.O. Box 422 Painesville, Ohio 44077-3938 Voice: (614) 557-8662 Fax: (614) 232-9541 Sean.Seibert@com.state.oh.us</p>	<p>Lake *</p>
<p>#11 Kela D. Thompson 6606 Tussing Rd, PO Box 4009 Reynoldsburg, Ohio 43068-9009 Voice: (614) 728-5007 Fax: (614) 232-9537 Kela.Thompson@com.state.oh.us</p>	<p>Franklin *</p>

*** Headquarter County**

<p>Stephen Clegg, Chief 6606 Tussing Road, PO Box 4009 Reynoldsburg, Ohio 43068-9009 Voice: (614) 728-8686 Fax: (614) 728-8639 Stephen.Clegg@com.state.oh.us</p>	<p>#90 Jackie Clark, Supervisor 6606 Tussing Rd, PO Box 4009 Reynoldsburg, Ohio 43068-9009 Voice: (614) 728-5019 Fax: (614) 222-2357 Jackie.Clark@com.state.oh.us</p>
---	---



Mike DeWine
Governor

Sheryl Maxfield
Director

PREVAILING WAGE GUIDE FOR PUBLIC AUTHORITIES

OHIO DEPARTMENT OF COMMERCE

Division of Industrial Compliance
Bureau of Wage and Hour Administration
6606 Tussing Road, PO Box 4009
Reynoldsburg, Ohio 43068-9009
Phone: 614-644-2239
Fax: 614-728-8639
www.com.ohio.gov
TTY/TDD: 1-800-750-0750

The Ohio Department of Commerce is an Equal Opportunity Employer and Service Provider

PREVAILING WAGE THRESHOLD LEVELS

IMPORTANT NOTICE

Before advertising for bids, contracting, or undertaking construction with its own forces, to construct a public improvement, the Public Authority shall have the Ohio Department of Commerce-Division of Industrial Compliance, Bureau of Wage and Hour Administration determine the prevailing rates of wages for workers employed on the public improvement. The wage determination must be included in the project specifications and printed on the bidding blanks where work is done by contract.

“New” construction threshold for <i>Building Construction</i>:	\$250,000
---	------------------

“Reconstruction, enlargement, alteration, repair, remodeling, renovation, or painting” threshold level for <i>Building Construction</i>:	\$75,000
---	-----------------

As of January 1, 2018:	
“New” construction that involves <i>roads, streets, alleys, sewers, ditches and other works connected to road or bridge construction</i> threshold level has been adjusted to:	\$91,150

“Reconstruction, enlargement, alteration, repair, remodeling, renovation, or painting” that involves <i>roads, streets, alleys, sewers, ditches and other works connected to road or bridge construction</i> threshold level has been adjusted to:	\$27,309
---	-----------------

- A) Thresholds are to be adjusted biennially by the Director of the Ohio Department of Commerce.
- B) Biennial adjustments to threshold levels are made according to the Building Cost for Skilled Labor Index published by McGraw-Hill’s Engineering News-Record, but may not increase or decrease more than 3% for any year.

If there are questions concerning this notification, please contact:

Ohio Department of Commerce
 Division of Industrial Compliance
 Bureau of Wage and Hour Administration
 6606 Tussing Road, PO Box 4009
 Reynoldsburg, Ohio 43068-9009
 Phone: 614-644-2239
 Fax: 614-728-8639
www.com.ohio.gov

Public Authority Responsibilities
ORC Chapter 4115: Wages and Hours on Public Works
(Prevailing Wage Coordinator)

1. Before advertising for bids, contracting, or undertaking construction with its own forces, to construct a public improvement, the public authority shall have the Ohio Department of Commerce, Division of Industrial Compliance, Bureau of Wage and Hour Administration determine the prevailing rates of wages for workers employed on the public improvement. The wage determination must be included in the project specifications and printed on the bidding blanks where work is done by contract.
 - a) "New" construction has a threshold level of **\$250,000.**
 - b) "Reconstruction, enlargement, alteration, repair, remodeling, renovation, or painting" has a threshold level of **\$75,000.**
 - c) "New" construction that involves roads, streets, alleys, sewers, ditches and other works connected to road or bridge construction has a threshold level of **\$84,314.**
 - d) "Reconstruction, enlargement, alteration, repair, remodeling, renovation, or painting" that involves roads, streets, alleys, sewers, ditches and other works connected to road or bridge construction has a threshold of **\$25,261.**
 - i.) Thresholds are to be adjusted biennially by the Director of Ohio Department of Commerce, Division of Industrial Compliance, Bureau of Wage and Hour Administration.
 - ii.) Biennial adjustments to threshold levels are made according to the Price Deflator for Construction Index, United States Department of Commerce, Bureau of the Census, but may not increase or decrease more than 3% for any year.
2. Every contract for public work shall contain a provision that each worker employed by the contractor or subcontractor, or other person about or upon the public work, must be paid the prevailing rate of wages.
3. If contracts are not awarded or construction undertaken within ninety days (90) from the date of the determination of the prevailing wage there shall be a re-determination of the wage rates before the contract is awarded.
4. Within **seven (7) working days** after the receipt of notification of a change in the prevailing wage rates, the public authority shall notify all affected contractors and subcontractors. If it is determined that a contractor or subcontractor has violated sections 4115.03 to 4115.16 of the Ohio Revised Code because they were not notified as required, **the public authority is liable** for any back wages, fines, damages, court costs and attorney's fees for the period of time covering the receipt of wage changes, until they give the required notice.
5. No public authority shall award a contract for a public improvement to any contractor or subcontractor whose name appears on the list of debarred contractors. This list is filed with the Secretary of State by the Ohio Department of Commerce-Division of Industrial Compliance & Labor-Bureau of Wage and Hour Administration **The filing of the notice of conviction with the secretary of state constitutes notice to all public authorities.** These contractors are prohibited from working on public improvements for periods ranging from one to three years. The list of debarred contractors can be located on the website www.com.ohio.gov/laws
6. A public authority must designate and appoint **one of its own employees** to serve as the Prevailing Wage Coordinator during the life of the contract for constructing the public improvement. A Prevailing Wage Coordinator must be appointed no later than ten days before the first payment of wages by contractors to employees working on the public improvement.

PUBLIC AUTHORITY'S COMPLIANCE CHECKLIST FOR PREVAILING WAGE

Project:		Number:
Department:		Phone#:
PW Coordinator:		Phone#:
Architect/Engineer:		Phone#:
Contractor:		Phone#:
Contact Person:		Title:
General Contractor:		Prime Contractor:
		Construction Mgr:
Date Completed		Compliance Item Description
	1.	Request Prevailing Wage Determination Schedule from ODOC-DIC-Wage & Hour
	2.	Received Prevailing Wage Determination Schedule
	3.	Incorporate Determination Schedule in Specs./Bidding Blanks
	4.	Incorporate notice of Prevailing Wage requirements in Invitation for Bids/Notice to Bidders
	5.	Incorporate Prevailing Wage requirements in Contract
	6.	Submit complete Invitation for Bid to ODOC-DIC-Wage & Hour
	7.	Invitation for Bids
	8.	Bid Opening
	9.	Check Listing of Violators
	10.	Award of Contract. (see note)
	11.	Submit Bid Tabulation/Award to ODOC-DIC-WAGE & HOUR
	12.	Notice to Successful Bidder
	13.	Work Commenced...(see note)
	14.	Appoint Prevailing Wage Coordinator
	15.	Received list of Subcontractors' names, addresses, phone #'s & email's
	16.	Received Payroll Date Schedule
	17.	Received Registered Apprenticeship Agreement Certifications
	18.	Received Deduction Agreements
	19.	Received Payroll Reports with Certification...(see attachment)
	20.	Visited project site
	21.	Received Changes to Determination Schedule
	22.	Notice to Contractors of Determination Schedule change
	23.	Request Final Compliance Affidavit from contractors & subcontractors
	24.	Received Final Affidavits from all contractors & subcontractors
	25.	Certify Final Payment

Note: If contract is not awarded or construction undertaken within 90 days from the date of establishment of the Prevailing Wage Rates, a re-determination of the Prevailing Wage Rates is required.

REQUEST FOR STATE OF OHIO PREVAILING WAGE RATES

Date		(Mark (X) One) <input type="checkbox"/> ~ Residential <input type="checkbox"/> ~ Construction
Project Information (only one project and one county per request form please)		
County of Project	Project Name	This form MUST be filled out COMPETELY & CORRECTLY for us to process your request. Forms not completed correctly will be RETURNED TO THE SENDER.
Site Address	City	
Owner/Public Authority		Prevailing Wage Rates can be obtained on the website www.com.ohio.gov
Address	Telephone Number	ODOC-DIC-WAGE & HOUR DATE STAMP
City	Zip Code	
PW Coordinator	Telephone Number	
Issuing Authority of Bonds	Type of Financing	
Estimated Total Overall Project Cost		PLEASE MAIL THIS REQUEST TO: Ohio Department of Commerce Division of Industrial Compliance Bureau of Wage & Hour Administration 6606 Tussing Road, PO Box 4009 Reynoldsburg, Ohio 43068-9009 PHONE: (614) 644-2239 FAX: (614) 728-8639
<input type="checkbox"/> New Construction <input type="checkbox"/> "Old" Construction * A copy of this form will be returned to you with your wage rates. You must send that copy to us with your bid tabulations once the contract has been awarded.		
Expected Date of Contract Award		
Projected Completion Date		ODOC-DIC-W&H DATE STAMP (bid tab)
Send Wage Rates to: (contractors are charged \$5.00 per county)		
<input type="checkbox"/> Mail <input type="checkbox"/> Pick Up <input type="checkbox"/> Federal Express Account Number		
Name	Company or Public Authority	
Address		ODOC-DIC-W&H DATE STAMP (bid tab)
City	Zip	
Telephone Number		
* "Old" construction is reconstruction, enlargement, alteration, repair, remodeling, renovation, or painting.		

BID TABULATION SHEET

Please attach a copy of your original dated and stamped **“Request for Prevailing Wage Rates”** with this **Bid Tabulation**. Please check mark which company was awarded the contract for the project.
(Note: DO NOT SEND UNTIL THE CONTRACT HAS BEEN OFFICIALLY AWARDED.)

Ohio Department of Commerce
 Division of Industrial Compliance, Bureau of Wage & Hour
 6606 Tussing Road, PO Box 4009
 Reynoldsburg, Ohio 43068-9009
 (Phone) 614-644-2239, (Fax) 614-728-8639 www.com.ohio.gov

Contracting Public Authority:

Project Name:

Project #:

Bid Date:

Estimate:

Contract Description: General HVAC Electrical Plumbing Asbestos Other:

AWARDED TO (CHECK)	LIST OF THE BIDDING CONTRACTORS	TOTAL BID AMOUNT
<input type="checkbox"/>		
<input type="checkbox"/>		
<input type="checkbox"/>		
<input type="checkbox"/>		
<input type="checkbox"/>		
<input type="checkbox"/>		
<input type="checkbox"/>		
<input type="checkbox"/>		
<input type="checkbox"/>		
<input type="checkbox"/>		
<input type="checkbox"/>		
<input type="checkbox"/>		
<input type="checkbox"/>		
<input type="checkbox"/>		
<input type="checkbox"/>		
<input type="checkbox"/>		
<input type="checkbox"/>		
<input type="checkbox"/>		
<input type="checkbox"/>		
<input type="checkbox"/>		

SUBMITTED BY

Print Name:

Title:

Telephone Number: ()

FAX #:

EMAIL:

Signature:

Date:

INDUSTRIAL DEVELOPMENT BONDS

Bond Projects require the Public Authority to keep the following information on file			
1. Type of Bonds issued:		Amount:	
2. The total cost of the Project:			
3. The other type of financing involved in the project:			
4. Portion of the project being constructed with each type of financing:			
5. Are Prevailing Wage Rates being applied to all construction on the project: <input type="checkbox"/> Yes <input type="checkbox"/> No			
6. The name of the political subdivision who issued the bonds:			
7. When were the bonds issued:			
8. For what purpose were the bonds issued:			
9. Who handles the funds once the bonds are sold:			
10. Who is the lending institution that purchased the bonds:			
11. How are the funds to be paid out:			
12. When are the funds to be paid out:			
13. Who is the Bond Council:			
14. Who has been appointed as the Prevailing Coordinator:			
PWC Address:			
City:	OHIO	Zip:	Telephone #:
15. Obtain a copy of the inducement and other official documents for the issuance of the bonds.			



Mike DeWine
Governor

Sheryl Maxfield
Director

PREVAILING WAGE GUIDELINES

FOR THE

PUBLIC AUTHORITY'S

PW COORDINATOR

OHIO DEPARTMENT OF COMMERCE

Division of Industrial Compliance and Labor

Bureau of Wage and Hour Administration

6606 Tussing Road, PO Box 4009

Reynoldsburg, Ohio 43068-9009

Phone: 614-644-2239

Fax: 614-728-8639

www.com.ohio.gov

TTY/TDD: 1-800-750-0750

The Ohio Department of Commerce is an Equal Opportunity Employer and Service Provider

Prevailing Wage Coordinator Guidelines

For more detailed information please refer to Chapter 4115 of the Ohio Revised Code

- A. Attend any pre-bid and/or pre-construction meetings.
 - 1. To explain the prevailing wage rate requirements.
 - 2. To explain the contractor's responsibilities.
- B. Set up and maintain files containing all contractors' and subcontractors' payroll reports, affidavits, and related documents. These files must be available for public inspection.
- C. Obtain from each contractor a list of their subcontractors' names, addresses, telephone numbers, and email addresses.
- D. Require each contractor and subcontractor to provide their project dates. This will be used to make a time schedule for receiving their certified payrolls.
- E. Obtain from each contractor, the name and address of their Bonding\Surety Company.
- F. Obtain from out-of-state corporations, the name and address of their Statutory Agent. (This agent must be located in the State of Ohio and registered with the Ohio Secretary of State.)
 - 1. Records made in connection with the public improvement must not be removed from the State of Ohio for the period of one year following the completion of the project.
- G. Supply contractors with any changes in the Prevailing Wage Rates.
- H. Within two weeks after the first pay, obtain a certified payroll report from each contractor. A certified report is one that is sworn to and signed by the contractor.
 - 1. If the job will exceed four months, all reports after the initial report can be filed once per month. (The initial report must be filed within two weeks.)
 - 2. If the job will last less than four months, all reports are to be filed weekly after the initial report.
- I. Establish and follow procedures to monitor compliance by contractors and subcontractors.
 - 1. Visit project to verify posting requirements and job classifications.
 - 2. Review certified payroll reports to ensure they are submitted in a timely fashion and complete with the following information for each employee:
 - a) Name, current address, and their social security number or last 4 when permitted
 - b) Classification (must be specific for laborers and operators, including level)
 - c) Hours worked on the project
 - d) Hourly rate
 - e) Fringe benefits, if applicable
 - f) Total hours worked for the week (all jobs)
 - g) Gross wages, all deductions, net pay
 - 3. Compare rates and fringes reported to rates in prevailing wage schedule.
- J. Upon completion of the project and prior to the final payment, require an affidavit of compliance from each contractor and subcontractor. **No public authority shall make final payment to any contractor or subcontractor unless the final affidavits have been filed by the respective contractor and subcontractor. (O.R.C. section 4115.07)**
- K. Report any non-compliance to Ohio Department of Commerce, Division of Industrial Compliance, Bureau of Wage & Hour Administration. The PW complaint form and instructions can be obtained on the website www.com.ohio.gov.

RECORD OF THE CERTIFIED PAYROLL REPORTS RECEIVED

Project:		Number:
Contractor:		Phone #: Email:
General Contractor:	Prime Contractor:	Subcontractor:
Date work commenced:	Completed:	Final Affidavit:

Payroll	Payroll Date	Date Received		Payroll	Payroll Date	Date Received
1				33		
2				34		
3				35		
4				36		
5				37		
6				38		
7				39		
8				40		
9				41		
10				42		
11				43		
12				44		
13				45		
14				46		
15				47		
16				48		
17				49		
18				50		
19				51		
20				52		
21				53		
22				54		
23				55		
24				56		
25				57		
26				58		
27				59		
28				60		
29				61		
30				62		
31				63		
32				64		

PREVAILING WAGE INVESTIGATION\EMPLOYEE INTERVIEW

Failure to complete this interview form may reduce our ability to recover back wages which may be owed to you.

Project:		Case #:	
Address:		City:	County:
Employee Name:			Last 4 digits of the SS#:
Address:	City:	State:	Zip:
Telephone #: (Home)	(Work)	Email:	Best time to be reached:
Another source by which we can contact you. (Someone not living at your address):			
Name:		Relationship:	Telephone #:
Contractor's Name:		Telephone #:	
Address:		City:	State: Zip:
Date hired:	Date started on this project :	Approximate hours - Straight time:	Overtime:
Method of recording hours: <input type="checkbox"/> Time Card <input type="checkbox"/> Called into office		Recorded by: <input type="checkbox"/> Employee <input type="checkbox"/> Foreman	
Did you keep a personal record of your hours worked on this project? <input type="checkbox"/> Yes <input type="checkbox"/> No		Do you have check stubs? <input type="checkbox"/> Yes <input type="checkbox"/> No	
Did anyone else keep a personal record ? <input type="checkbox"/> Yes <input type="checkbox"/> No		If yes, who:	
List your job classification(s):		<input type="checkbox"/> Journeyman <input type="checkbox"/> Helper <input type="checkbox"/> Apprentice - Level	
List your specific job duties:		List tools\equipment used:	
Hourly rate of pay for this project:		Your regular rate of pay:	
Fringe benefits paid by contractor: <input type="checkbox"/> None <input type="checkbox"/> Health Insurance <input type="checkbox"/> Life Insurance <input type="checkbox"/> Pension <input type="checkbox"/> Bonus ~ Vacation - Amount _____ <input type="checkbox"/> Holidays - Amount _____ <input type="checkbox"/> Apprenticeship training <input type="checkbox"/> Profit Sharing ~ Other (list):			
Did you work overtime? <input type="checkbox"/> Yes <input type="checkbox"/> No		Were hours over 40 per week paid at time and one half? <input type="checkbox"/> Yes <input type="checkbox"/> No	
When is your pay day?		Method of payment: <input type="checkbox"/> Check <input type="checkbox"/> Cash <input type="checkbox"/> Direct Deposit	
List names of co-workers on this project:			
Comments:		Please provide a detailed list of the dates, times and hours worked within each classification that may apply to the work performed on a separate sheet.	
SIGNATURE AND NOTARY			
Affiant is further informed that Section 2921.13 of the Ohio Revised Code provides a penalty of a misdemeanor of the first degree and that prosecution will be pursued of those persons who "knowingly swear or affirm the truth of a false statement when ...the statement is sworn or affirmed before a notary public..." Sworn to before me and subscribed by the said:		I hereby certify that this is a true statement to the best of my knowledge and belief.	
_____		Signature _____ Date _____	
in my presence this _____ day of _____, 20_____.		Return to: Ohio Department of Commerce Division of Industrial Compliance & Labor Bureau of Wage and Hour Administration 6606 Tussing Road P.O. Box 4009 Reynoldsburg, Ohio 43068-9009 (614) 644-2239 www.com.ohio.gov	
_____ Notary Public			
Signature of PW Coordinator:			Date:

EMPLOYEE VS. INDEPENDENT CONTRACTOR

EMPLOYEE	↔	<input checked="" type="checkbox"/> YES	Does the employer have the right to control and direct worker?	<input type="checkbox"/> NO	↔	INDEPENDENT CONTRACTOR
EMPLOYEE	↔	<input checked="" type="checkbox"/> YES	Does the worker receive instructions about how and where the work is to be done instead of the employer merely specifying the desired result?	<input type="checkbox"/> NO	↔	INDEPENDENT CONTRACTOR
EMPLOYEE	↔	<input checked="" type="checkbox"/> YES	Is payment based on time spent rather than a set price for the work to be performed?	<input type="checkbox"/> NO	↔	INDEPENDENT CONTRACTOR
EMPLOYEE	↔	<input checked="" type="checkbox"/> YES	Does the worker devote virtually all his working time to the employer rather than offering services to the general public?	<input type="checkbox"/> NO	↔	INDEPENDENT CONTRACTOR
EMPLOYEE	↔	<input checked="" type="checkbox"/> YES	Does the worker performing services make their services available to the general public and/or other businesses?	<input type="checkbox"/> NO	↔	INDEPENDENT CONTRACTOR
EMPLOYEE	↔	<input checked="" type="checkbox"/> YES	Is there a continuing relationship between employer and worker?	<input type="checkbox"/> NO	↔	INDEPENDENT CONTRACTOR
EMPLOYEE	↔	<input checked="" type="checkbox"/> YES	Can the worker be discharged at will?	<input type="checkbox"/> NO	↔	INDEPENDENT CONTRACTOR
EMPLOYEE	↔	<input checked="" type="checkbox"/> YES	Did the employer train the worker for the job?	<input type="checkbox"/> NO	↔	INDEPENDENT CONTRACTOR
EMPLOYEE	↔	<input checked="" type="checkbox"/> YES	Does the employer have employees performing the same work as the independent contractor?	<input type="checkbox"/> NO	↔	INDEPENDENT CONTRACTOR

EMPLOYEE VS. INDEPENDENT CONTRACTOR-continued

EMPLOYEE ↔ YES NO ↔ INDEPENDENT CONTRACTOR

Does the worker perform services personally rather than delegating them to others?

EMPLOYEE ↔ YES NO ↔ INDEPENDENT CONTRACTOR

Does the employer set a specific time when the individual services are to be performed?

EMPLOYEE ↔ YES NO ↔ INDEPENDENT CONTRACTOR

Does the employer furnish the tools and materials used by the worker performing services?

EMPLOYEE ↔ YES NO ↔ INDEPENDENT CONTRACTOR

Is the employer assuming all the financial risk, rather than the worker making a significant financial investment in the job and having the opportunity to realize a profit or loss from the work?

EMPLOYEE ↔ NO YES ↔ INDEPENDENT CONTRACTOR

Does the individual performing the services publicly advertise these services in for example, the newspaper or yellow pages ?

EMPLOYEE ↔ NO YES ↔ INDEPENDENT CONTRACTOR

Does the individual performing the services have a business license?

EMPLOYEE ↔ NO YES ↔ INDEPENDENT CONTRACTOR

Does the individual performing the services operate d.b.a. or under a tradename?



Mike DeWine
Governor

Sheryl Maxfield
Director

PREVAILING WAGE GUIDE FOR CONTRACTORS

OHIO DEPARTMENT OF COMMERCE

Division of Industrial Compliance
Bureau of Wage and Hour Administration
6606 Tussing Road, PO Box 4009
Reynoldsburg, Ohio 43068-9009
Phone: 614-644-2239
Fax: 614-728-8639
www.com.ohio.gov
TTY/TDD: 1-800-750-0750

The Ohio Department of Commerce is an Equal Opportunity Employer and Service Provider

OHIO DEPARTMENT OF COMMERCE
Division of Industrial Compliance
Bureau of Wage and Hour Administration
Chief, Stephen Clegg

6606 Tussing Road, PO Box 4009
Reynoldsburg, Ohio 43068-9009
614-644-2239
fax: 614-728-8639
<http://www.com.ohio.gov>

INVESTIGATORS and THEIR HEADQUARTER COUNTY

#48 Dave Horvath PO Box 1512 Lima, Ohio 45802-1512 Voice: (419) 302-1200 Fax: (614) 728-8639 Dave.Horvath@com.state.oh.us	Allen *
#30 Mike McKee P.O. Box 1342 Cambridge, Ohio 43725-2247 Voice/Fax: (740) 432-1987 Michael.McKee@com.state.oh.us	Guernsey*
#56 Shawn Miles P.O. Box 2547 North Canton, Ohio 44720 Voice/Fax: (614) 496-9076 Shawn.Miles@com.state.oh.us	Stark *
#37 David Rice P.O. Box 41241 Dayton, Ohio 45441 Voice/Fax: (740) 502-0883 Dave.Rice@com.state.oh.us	Montgomery *
#35 Sean Seibert P.O. Box 422 Painesville, Ohio 44077-3938 Voice: (614) 557-8662 Fax: (614) 232-9541 Sean.Seibert@com.state.oh.us	Lake *
#11 Kela D. Thompson 6606 Tussing Rd, PO Box 4009 Reynoldsburg, Ohio 43068-9009 Voice: (614) 728-5007 Fax: (614) 232-9537 kela.thompson@com.state.oh.us	Franklin *

* Headquarter County

Stephen Clegg, Chief 6606 Tussing Road, PO Box 4009 Reynoldsburg, Ohio 43068-9009 Voice: (614) 728-8686 Fax: (614) 728-8639 Stephen.Clegg@com.state.oh.us	#90 Jackie Clark, Supervisor 6606 Tussing Rd, PO Box 4009 Reynoldsburg, Ohio 43068-9009 Voice: (614) 728-5019 Fax: (614) 222-2357 Jackie.Clark@com.state.oh.us
--	--



PREVAILING WAGE CONTRACTOR RESPONSIBILITIES

This is a summary of prevailing wage contractors' responsibilities. For more detailed information please refer to Chapter 4115 of the Ohio Revised Code

General Information

Ohio's prevailing wage laws apply to all public improvements financed in whole or in part by public funds when the total overall project cost is fairly estimated to be more than \$250,000 for new construction or \$75,000 for reconstruction, enlargement, alteration, repair, remodeling, renovation, or painting.

Ohio's prevailing wage laws apply to all public improvements financed in whole or in part by public funds when the total overall project cost is fairly estimated to be more than \$91,150 for new construction that involves roads, streets, alleys, sewers, ditches and other works connected to road or bridge construction or \$27,309 for reconstruction, enlargement, alteration, repair, remodeling, renovation, or painting of a public improvement that involves roads, streets, alleys, sewers, ditches and other works connected to road or bridge construction.

- a) Thresholds are to be adjusted biennially by the Administrator of Ohio Department of Commerce, Division of Industrial Compliance and Labor, Bureau of Wage and Hour Administration
- b) Biennial adjustments to threshold levels are made according to the Price Deflator for Construction Index, United States Department of Commerce, Bureau of the Census*, but may not increase or decrease more than 3% for any year

Penalties for violation

Violators are to be assessed the wages owed, plus a penalty of 100% of the wages owed.

Intentional Violations

If an intentional violation is determined to have occurred, the contractor is prohibited from contracting directly or indirectly with any public authority for the construction of a public improvement. Intentional violation means "a willful, knowing, or deliberate disregard for any provision" of the prevailing wage law and includes but is not limited to the following actions:

- Intentional failure to submit payroll reports as required, or knowingly submitting false or erroneous reports.
- Intentional misclassification of employees for the purpose of reducing wages.
- Intentional misclassification of employees as independent contractors or as apprentices.
- Intentional failure to pay the prevailing wage.
- Intentional failure to comply with the allowable ratio of apprentices to skilled workers as required by the regulations established by Ohio Department of Commerce, Division of Industrial Compliance and Labor, Bureau of Wage and Hour Administration.
- Intentionally employing an officer, of a contractor or subcontractor, that is known to be prohibited from contracting, directly or indirectly, with a public authority.



Responsibilities

- A. Pay the prevailing rate of wages as shown in the wage rate schedules issued by the Ohio Department of Commerce, Division of Industrial Compliance and Labor, Bureau of Wage and Hour Administration, for the classification of work being performed.
 1. Wage rate schedules include all modifications, corrections, escalations, or reductions to wage rates issued for the project.
 2. Overtime must be paid at time and one-half the employee's base hourly rate. Fringe benefits are paid at straight time rate for all hours including overtime.
 3. Prevailing wages must be paid in full without any deduction for food, lodging, transportation, use of tools, etc.; unless, the employee has voluntarily consented to these deductions in writing. The public authority and the Director of Ohio Department of Commerce, Division of Industrial Compliance and Labor, Bureau of Wage and Hour Administration - must approve these deductions as fair and reasonable. Consent and approval must be obtained before starting the project.

- B. Use of Apprentices and Helpers cannot exceed the ratios permitted in the wage rate schedules.
 1. Apprentices must be registered with the U.S. Department of Labor Bureau of Apprenticeship and Training.
 2. Contractors must provide the Prevailing Wage Coordinator a copy of the Apprenticeship Agreement for each apprentice on the project.

- C. Keep full and accurate payroll records available for inspection by any authorized representative of the Ohio Department of Commerce, Division of Industrial Compliance, and Labor, Bureau of Wage and Hour Administration or the contracting public authority, including the Prevailing Wage Coordinator. Records should include but are not limited to:
 1. Time cards, time sheets, daily work records, etc.
 2. Payroll ledger/journals and canceled checks/check register.
 3. Fringe benefit records must include program, address, account number, & canceled checks.
 4. Records made in connection with the public improvement must not be removed from the State for one year following the completion of the project.
 5. Out-of-State Corporations must submit to the Ohio Secretary of State the full name and address of their Statutory Agent in Ohio.

- D. Prevailing Wage Rate Schedule must be posted on the job site where it is accessible to all employees.

- E. Prior to submitting the initial payroll report, supply the Prevailing Wage Coordinator with your project dates to schedule reporting of your payrolls.

- F. Supply the Prevailing Wage Coordinator a list of all subcontractors including the name, address, and telephone number for each.
 1. **Contractors are responsible for their subcontractors' compliance with requirements of Chapter 4115 of the Ohio Revised Code.**



- G. Before employees start work on the project, supply them with written notification of their job classification, prevailing wage rate, fringe benefit amounts, and the name of the Prevailing Wage Coordinator for the project. A copy of the completed signed notification should be submitted to Prevailing Wage Coordinator.
- H. Supply all subcontractors with the Prevailing Wage Rates and changes.
- I. Submit certified payrolls within two (2) weeks after the initial pay period. Payrolls must include the following information:
 - 1. Employees' names, addresses, and social security numbers.
 - a. Corporate officers/owners/partners and any salaried personnel who do physical work on the project are considered employees. All rate and reporting requirements are applicable to these individuals.
 - 2. Employees' work classification.
 - a. Be specific about the laborers and/or operators (Group)
 - b. For all apprentices, show level/year and percent of journeyman's rate
 - 3. Hours worked on the project for each employee.
 - a. The number of hours worked in each day and the total number of hours worked each week.
 - 4. Hourly rate for each employee.
 - a. The minimum rate paid must be the wage rate for the appropriate classification. The Department's Wage Rate Schedule sets this rate.
 - b. All overtime worked is to be paid at time and one-half for all hours worked more than forty (40) per week.
 - 5. Where fringes are paid into a bona fide plan instead of cash, list each benefit and amount per hour paid to program for each employee.
 - a. When the amount contributed to the fringe benefit plan and the total number of hours worked by the employee on all projects for the year are documented, the hourly amount is calculated by dividing the total contribution of the employer by the total number of hours worked by the employee.
 - b. When the amount contributed to the fringe benefit is documented but not the total hours worked, the hourly amount is calculated by **dividing the total yearly contribution by 2080**.
 - 6. Gross amount earned on all projects during the pay period.
 - 7. Total deductions from employee's wages.
 - 8. Net amount paid.
- J. The reports shall be certified by the contractor, subcontractor, or duly appointed agent stating that the payroll is correct and complete; and that the wage rates shown are not less than those required by the O.R.C. 4115.
- K. Provide a Final Affidavit to the Prevailing Wage Coordinator upon the completion of the project.

PREVAILING WAGE NOTIFICATION to EMPLOYEE

4115.05...the contractor or subcontractor shall furnish each employee NOT covered by a collective bargaining agreement written notification of the job classification to which the employee is assigned, the prevailing wage determined to be applicable to that classification, separated into the hourly rate of pay and the fringe payments, and the identity of the prevailing wage coordinator appointed by the public authority. The contractor or subcontractor shall furnish the same notification to each affected employee every time the job classification of the employee is changed.

Project Name:		Job Number:
Contractor:		
Project Location:		
Prevailing Wage Coordinator	Employee	
Public Authority:	Name:	
Name of PWC:	Street:	
Street:	City:	
City:	State/Zip:	
State/Zip:	Phone:	Email:
Phone:	Last 4 Digits of SS #:	

You will be performing work on this project that falls under these classifications. You will be paid the appropriate rate for the type of work you are performing.

Classification:	Prevailing Wage Rate Total Package:	Minus your fringe benefits *:	Your hourly base rate and overtime:
			/
			/
			/
			/
			/
			/

Hourly fringe benefits paid on your behalf by this company (Yearly amount the company pays divided by 2080):

Fringe	Amount	Fringe	Amount
Health Insurance		Vacation	
Life Insurance		Holiday	
Pension		Sick Pay	
Other (Specify)		Training	
Other (Specify)		Total Hourly Fringes *	

Contractor's Signature:	Date:
Employee's Signature:	Date:

INSTRUCTIONS FOR PREPARING CERTIFIED PAYROLL REPORTS

General

Contractors and subcontractors are required by law to submit certified payroll reports for work on projects covered by Ohio's Prevailing Wage Law. This form meets the reporting requirements established by Ohio Revised Code Chapter 4115. The use of this form is not mandatory; employers may submit their own forms provided that all of the required information is included. This form may be reproduced, or additional copies obtained from:

Ohio Department of Commerce
Division of Industrial Compliance and Labor
Bureau of Wage & Hour Administration
6606 Tussing Rd, P. O. Box 4009
Reynoldsburg, OH 43068-9009
Phone: (614) 644-2239
www.com.ohio.gov

Certified Payroll Heading

Employer name and address: Company's full name and address... Indicate if the company is a subcontractor.

Subcontractor: Check and list the name of the General Contractor or Prime.

Project: Name and location of the project, including county.

Contracting Public Authority: Name and address of the contracting public authority... (Owner of the project).

Week Ending: Month, day, and year for the last day of the reporting period.

Payroll #: Indicate first, second, third, etc. payroll filed by the company for the project.

Page Indicator: number of pages included in the report.

Project Number: Determined by the public authority... if there is no number leave it blank.

Payroll Information by Column

- Employee Name, Address and Social Security number:** This information must be provided for all employees that perform physical labor on the project. Corporate officers, partners, and salaried employees are considered employees and must be paid the prevailing rate. Individual sole proprietors do not have to pay themselves prevailing rate but must report their hours on the project.
- Work Class:** List classification of work actually performed by employee. If unsure of work classification, consult the Ohio department of Commerce, Wage and Hour Bureau. Employees working more than one classification should have separate line entries for each classification. Indicate what year/level for Apprentices. Be specific when using laborer and operator classifications; for example, Backhoe Operator or Asphalt Laborer.
- Hours Worked, Day & Date:** In the first row of column 3 enter days of pay period example; M T W T H F S S. The second row is for the date that corresponds with each day for the pay period. In the employee information section enter the number of hours worked on the prevailing wage project and which day the hours were worked. Separate rows are labeled for (ST) straight time hours and (OT) overtime hours. All hours worked after 40, must be paid at the appropriate overtime rate.
- Project Total Hours:** Total the hours entered for pay period.
- Base Rate:** Enter actual rate per hour paid to the employee. The overtime hourly rate is time and one-half the base rate listed in the prevailing wage schedule plus fringe benefits at straight time rate. The prevailing wage schedule lists the base rate plus fringe benefit amounts. These amounts added together equal the total prevailing wage rate. Employers must pay this total amount in one of three ways.
 - Total rate may be paid in entirety in the base rate to the employee; in which case, the cash designation will be checked for fringe benefits.
 - Total rate may be paid as listed in prevailing wage rate schedule with total fringe amounts paid approved plans.
 - Total rate may be paid with a combination of base rate and fringe payments to approved plans in amounts other than those listed in schedule.
- Project Gross:** Enter total gross wages earned on the project for straight time and overtime. Project hours X base rate should equal project gross.
- Fringes:** If fringe benefits are paid in the hourly base rate, indicate this by marking the **Cash** space. If fringe benefits are paid to approved plans as listed in the prevailing wage rate schedule, mark the space **Approved Plans**. If fringe benefits are paid partially in the base rate and partially to approved plans, mark the space **Cash & Approved plans**. List the hourly amount paid to approved plans for each fringe. If payments are not made on a per hour basis, **calculate the hourly fringe credit by dividing the yearly employer contribution by** the lesser of: hours actually worked in the year (these must be documented) or **2080**. Fringe benefits include: **Employer's share** of health insurance, life insurance, retirement plan, bonus/profit sharing, sick pay, holiday pay, personal leave, vacation, and education/training programs. If unsure of a possible fringe benefit, contact the Ohio Department of Commerce - Division of Industrial Compliance and Labor - Bureau of Wage & Hour Administration.
- Total Hours All Jobs:** Total all hours worked during the pay period including non-prevailing wage jobs.
- Total Gross All Jobs:** Gross amount earned in the pay period for all hours worked.
- Self explanatory.
- Self explanatory.

Certified Payroll Report

Report for: Check if Subcontractor¹⁾ Contract No: _____ Payroll No: _____
 Company: ¹⁾ _____ If Sub, GC/Prime Contractor Name: _____
 Address: _____ Project Name & Location: _____ Week Ending: _____
 City, State, Zip _____ Public Authority (Owner): _____ Sheet:²⁾ _____ of _____
 Phone No: _____

1. Employee Name, Address, & SS# (Last 4 digits if permitted)	2. Work Class ³⁾	3. Prevailing Wage Project Hours Worked - Day & Date				4. Total Hours	5. Base Rate	6. Project Gross	7. Fringes:				8. Total Hrs for all Jobs	9. Total Gross on All Jobs			10. Total Deductions	11. Net Pay on All Jobs
		Fringe Rate Your Company Pays Per Hour							Approved Plans					Total	Gross on All Jobs	Deductions		
		H&W	Pens	Vac	Hol				Cash & Approved Plans	Cash	Approved Plans							
	OT																	
	ST																	
	OT																	
	ST																	
	OT																	
	ST																	
	OT																	
	ST																	
	OT																	
	ST																	

1) By signing below, I certify that: (1) I pay, or supervise the payment of the employees shown above; (2) during the pay period reported on this form, all hours worked on this project have been paid at the appropriate prevailing wage rate for the class of work done; (3) the fringe benefits have been paid as indicated above; (4) no rebates or deductions have been or will be made, directly or indirectly from the total wages earned, other than permissible deductions as defined in ORC Chapter 4115; and (5) apprentices are registered with the U.S. Dept. of Labor, Bureau of Apprenticeship and Training. I understand that the willful falsification of any of the above statements may subject the Contractor or Subcontractor to civil or criminal prosecution.

Type or Print Name and Title _____ Signature _____ Date _____

²⁾ Attach additional sheets as necessary. ³⁾ Type in continuous line, text will wrap.



Affidavit of Compliance
Prevailing Wages

I, _____ (Name of person signing affidavit) (Title)

do hereby certify that the wages paid to all employees of

_____ (Company Name)

for all hours worked on the

_____ (Project name and location)

project, during the period from _____ to _____ are in (Project Dates)

compliance with prevailing wage requirements of Chapter 4115 of the Ohio Revised Code. I further certify that no rebates or deductions have been or will be made, directly or indirectly, from any wages paid in connection with this project, other than those provided by law.

_____ (Signature of Officer or Agent)

Sworn to and subscribed in my presence this _____ day of _____, 20_____.

_____ (Notary Public)

The above affidavit must be executed and sworn to by the officer or agent of the contractor or subcontractor who supervises the payment of employees. This affidavit must be submitted to the owner (public authority) before the surety is released or final payment due under the terms of the contract is made.

THIS PAGE WAS LEFT BLANK INTENTIONALLY

Prevailing Wage Determination Cover Letter

County: WARREN ▼
Determination Date: 03/09/2022
Expiration Date: 06/09/2022

THE FOLLOWING PAGES ARE PREVAILING RATES OF WAGES ON PUBLIC IMPROVEMENTS FAIRLY ESTIMATED TO BE MORE THAN THE AMOUNT IN O.R.C. SEC. 4115.03 (b) (1) or (2), AS APPLICABLE.

Section 4115.05 provides, in part: "Where contracts are not awarded or construction undertaken within ninety days from the date of the establishment of the prevailing wages, there shall be a redetermination of the prevailing rate of wages before the contract is awarded." The expiration date of this wage schedule is listed above for your convenience only. This wage determination is not intended as a blanket determination to be used for all projects during this period without prior approval of this Department.

Section 4115.04, Ohio Revised Code provides, in part: "Such schedule of wages shall be attached to and made a part of the specifications for the work, and shall be printed on the bidding blanks where the work is done by contract..."

The contract between the letting authority and the successful bidder shall contain a statement requiring that mechanics and laborers be paid a prevailing rate of wage as required in Section 4115.06, Ohio Revised Code.

The contractor or subcontractor is required to file with the contracting public authority upon completion of the project and prior to final payment therefore an affidavit stating that he has fully complied with Chapter 4115 of the Ohio Revised Code.

The wage rates contained in this schedule are the "Prevailing Wages" as defined by Section 4115.03, Ohio Revised Code (the basic hourly rates plus certain fringe benefits). These rates and fringes shall be a minimum to be paid under a contract regulated by Chapter 4115 of the Ohio Revised Code by contractors and subcontractors. The prevailing wage rates contained in this schedule include the effective dates and wage rates currently on file. In cases where future effective dates are not included in this schedule, modifications to the wage schedule will be furnished to the Prevailing Wage Coordinator appointed by the public authority as soon as prevailing wage rates increases are received by this office.

"There shall be posted in a prominent and accessible place on the site of work a legible statement of the Schedule of Wage Rates specified in the contract to the various classifications of laborers, workmen, and mechanics employed, said statement to remain posted during the life of such contract." Section 4115.07, Ohio Revised Code.

Apprentices will be permitted to work only under a bona fide apprenticeship program if such program exists and if such program is registered with the Ohio Apprenticeship Council.

Section 4115.071 provides that no later than ten days before the first payment of wages is due to any employee of any contractor or subcontractor working on a contract regulated by Chapter 4115, Ohio Revised Code, the contracting public authority shall appoint one of his own employees to act as the prevailing wage coordinator for said contract. The duties of the prevailing wage coordinator are outlined in Section 4115.071 of the Ohio Revised Code.

Section 4115.05 provides for an escalator in the prevailing wage rate. Each time a new rate is established, that rate is required to be paid on all ongoing public improvement projects.

A further requirement of Section 4115.05 of the Ohio Revised Code is: "On the occasion of the first pay date under a contract, the contractor shall furnish each employee not covered by a collective bargaining agreement or understanding between employers and bona fide organizations of Labor with individual written notification of the job classification to which the employee is assigned, the prevailing wage determined to be applicable to that classification, separated into the hourly rate of pay and the fringe payments, and the identity of the prevailing wage Coordinator appointed by the public authority. The contractor or subcontractor shall furnish the same notification to each affected employee every time the job classification of the employee is changed."

Work performed in connection with the installation of modular furniture may be subject to prevailing wage.

THIS PACKET IS NOT TO BE SEPARATED BUT IS TO REMAIN COMPLETE AS IT IS SUBMITTED TO YOU. (Reference guidelines and forms are included in this packet to be helpful in the compliance of the Prevailing Wage law.)
wh1500

Prevailing Wage Rate Skilled Crafts

Name of Union: Asbestos Local 50 Zone 1

Change # : LCN01-2024ibAsbLoc50Zone1

Craft : Asbestos Worker Effective Date : 03/06/2024 Last Posted : 03/06/2024

	BHR		Fringe Benefit Payments					Irrevocable Fund		Total PWR	Overtime Rate	
			H&W	Pension	App Tr.	Vac.	Annuity	Other	LECET (*)			MISC (*)
Classification												
Asbestos Insulation Mechanic	\$35.61		\$9.20	\$8.35	\$0.50	\$0.00	\$3.75	\$0.10	\$0.00	\$0.00	\$57.51	\$75.31
Firestop Technician	\$35.61		\$9.20	\$8.35	\$0.50	\$0.00	\$3.75	\$0.10	\$0.00	\$0.00	\$57.51	\$75.31
Apprentice	Percent											
1st year	54.14	\$19.28	\$8.96	\$0.00	\$0.44	\$0.00	\$0.50	\$0.10	\$0.00	\$0.00	\$29.28	\$38.92
2nd year	65.85	\$23.45	\$9.20	\$0.95	\$0.44	\$0.00	\$0.85	\$0.10	\$0.00	\$0.00	\$34.99	\$46.71
3rd year	76.72	\$27.32	\$9.20	\$2.38	\$0.44	\$0.00	\$1.25	\$0.10	\$0.00	\$0.00	\$40.69	\$54.35
4th year	84.04	\$29.93	\$9.20	\$2.38	\$0.44	\$0.00	\$1.50	\$0.10	\$0.00	\$0.00	\$43.55	\$58.51

Special Calculation Note : *other is Labor Mgt Training Fund

Ratio :

- 1 Journeymen to 1 Apprentice
- 4 Journeymen to 1 Apprentice thereafter

Jurisdiction (* denotes special jurisdictional note) :

ATHENS, AUGLAIZE, BUTLER*, CLINTON, CRAWFORD, DELAWARE, FAIRFIELD, FAYETTE, FRANKLIN, GUERNSEY, HARDIN, HOCKING, KNOX, LICKING, LOGAN, MADISON, MARION, MORGAN, MORROW, MUSKINGUM, NOBLE, PERRY, PICKAWAY, ROSS, SHELBY, UNION, VINTON, WARREN*

Special Jurisdictional Note : Township of Butler County-Townships of Lemon and Madison. Warren County-Township of Cleer Creek, Franklin, Massie, Turtle Creek and Wayne

Details :

Prevailing Wage Rate Skilled Crafts

Name of Union: Asbestos Local 8 Heat & Frost Insulators

Change # : LCN01-2024ibLoc8

Craft : Asbestos Worker Effective Date : 03/06/2024 Last Posted : 03/06/2024

	BHR		Fringe Benefit Payments					Irrevocable Fund		Total PWR	Overtime Rate	
			H&W	Pension	App Tr.	Vac.	Annuity	Other	LECET (*)			MISC (*)
Classification												
Asbestos Insulators	\$34.23		\$8.64	\$9.35	\$0.45	\$0.00	\$3.50	\$0.00	\$0.00	\$0.00	\$56.17	\$73.28
Apprentice Rates for those that began BEFORE March 1, 2024												
1st Year	\$18.83		\$8.64	\$5.10	\$0.45	\$0.00	\$3.50	\$0.00	\$0.00	\$0.00	\$36.52	\$45.94
2nd Year	\$20.53		\$8.64	\$6.65	\$0.45	\$0.00	\$3.50	\$0.00	\$0.00	\$0.00	\$39.77	\$50.04
3rd Year	\$22.25		\$8.64	\$6.65	\$0.45	\$0.00	\$3.50	\$0.00	\$0.00	\$0.00	\$41.49	\$52.62
4th Year	\$23.96		\$8.64	\$6.65	\$0.45	\$0.00	\$3.50	\$0.00	\$0.00	\$0.00	\$43.20	\$55.18
Apprentice Rates for those that began AFTER March 1, 2024	Percent											
1st Year	55.00	\$18.83	\$8.64	\$5.10	\$0.45	\$0.00	\$0.00	\$0.00	\$0.00	\$0.00	\$33.02	\$42.43
2nd Year	59.98	\$20.53	\$8.64	\$6.65	\$0.45	\$0.00	\$0.00	\$0.00	\$0.00	\$0.00	\$36.27	\$46.54
3rd Year	65.00	\$22.25	\$8.64	\$6.65	\$0.45	\$0.00	\$3.50	\$0.00	\$0.00	\$0.00	\$41.49	\$52.61
4th Year	70.00	\$23.96	\$8.64	\$6.65	\$0.45	\$0.00	\$3.50	\$0.00	\$0.00	\$0.00	\$43.20	\$55.18

Special Calculation Note :

Ratio :

- 1 Journeyman to 1 Apprentice
- 2 Journeymen to 2 Apprentices
- 3 Journeymen to 3 Apprentices
- 3 Journeymen to 1 Apprentice thereafter

Jurisdiction (* denotes special jurisdictional note) :

ADAMS, BROWN, BUTLER*, CLERMONT, HAMILTON, HIGHLAND, WARREN*

Special Jurisdictional Note : In Butler County: townships of

fairfield, Hanover, Liberty, Milford, Morgan, Oxford, Ripley, Ross, St. Clair, Union & Wayne. In Warren County: Townships of Deerfield, Hamilton, Harlan, Salem, Union & Washington

Details :

All work in connection with Asbestos Removal, Abatement, Encapsulation, Lead Abatement, Hazardous Materials and Fire Stopping which is performed by employees in the Mechanic or Apprentice Classification shall be covered under the terms of this Agreement..

Prevailing Wage Rate Skilled Crafts

Name of Union: Asbestos Local 207 OH

Change # : LCN01-2018fbLoc207OH

Craft : Asbestos Worker Effective Date : 08/23/2018 Last Posted : 08/23/2018

	BHR	Fringe Benefit Payments						Irrevocable Fund		Total PWR	Overtime Rate
		H&W	Pension	App Tr.	Vac.	Annuity	Other	LECET (*)	MISC (*)		
Classification											
Asbestos Abatement	\$25.50	\$7.25	\$6.45	\$0.65	\$0.00	\$0.00	\$0.07	\$0.00	\$0.00	\$39.92	\$52.67
Trainee	\$16.50	\$7.25	\$1.50	\$0.65	\$0.00	\$0.00	\$0.07	\$0.00	\$0.00	\$25.97	\$34.22

Special Calculation Note :

Ratio :

3 Journeymen to 1 Trainee

Jurisdiction (* denotes special jurisdictional note) :

ADAMS, ASHLAND, ASHTABULA*, ATHENS, AUGLAIZE, BROWN, BUTLER*, CARROLL, CHAMPAIGN, CLARK, CLERMONT, CLINTON, COLUMBIANA, COSHOCTON, CRAWFORD, CUYAHOGA, DARKE, DELAWARE, FAIRFIELD, FAYETTE, FRANKLIN, GEauga, GREENE, GUERNSEY, HAMILTON, HARDIN, HARRISON, HIGHLAND, HOCKING, HOLMES, HURON, KNOX, LAKE, LICKING, LOGAN, LORAIN, MADISON, MAHONING, MARION, MEDINA, MIAMI, MONTGOMERY, MORGAN, MORROW, MUSKINGUM, NOBLE, PERRY, PICKAWAY, PORTAGE, PREBLE, RICHLAND, ROSS, SHELBY, STARK, SUMMIT, TRUMBULL, TUSCARAWAS, UNION, VINTON, WARREN*, WAYNE

Special Jurisdictional Note : Butler County:(townships of Fairfield,Hanover,Liberty,Milford,Morgan,Oxford,Ripley,Ross,StClair,Union & Wayne.) (Lemon & Madison) Warren County: (townships of: Deerfield, Hamilton, Harlan, Salem, Union & Washington). (Clear Creek, Franklin, Mossie, Turtle Creek & Wayne). Ashtabula County: (post offices & townships of Ashtabula, Austinburg, Geneva, Harperfield, Jefferson, Plymouth & Saybrook) (townships of Andover, Cherry Valley, Colbrook, Canneaut, Denmark, Dorset, East Orwell, Hartsgrove, Kingville, Lenox, Monroe,Morgan,New Lyme,North Kingsville, Orwell, Pierpoint, Richmond Rock Creek, Rome, Sheffield, Trumbull, Wayne, Williamsfield & Windsor) Erie County:(post offices & townships of Berlin, Berlin Heights,Birmingham,Florence ,Huron, Milan, Shinrock & Vermilion)

Details :

Asbestos & lead paint abatement including,but not limited to the removal or encapsulation of asbestos & lead paint,all work in conjunction with the preparation of the removal of same & all work in conjunction with the clean up after said removal.The removal of all insulation materials, whether they contain asbestos or not, from mechanical systems (pipes, boilers, ducts, flues, breaching, etc.) is recognized as being the exclusive work of the Asbestos Abatement Workers.

On all mechanical systems (pipes, boilers, ducts, flues, breaching, etc.) that are going to be demolished, the removal of all insulating materials whether they contain asbestos or not shall be the exclusive work of the Laborers. An Abatement Journeyman is anyone who has more than 300 hours in the Asbestos Abatement field.

Prevailing Wage Rate Skilled Crafts

Name of Union: Boilermaker Local 105

Change # : LCN02-2013fbLoc 105

Craft : Boilermaker Effective Date : 10/01/2013 Last Posted : 09/25/2013

	BHR		Fringe Benefit Payments					Irrevocable Fund		Total PWR	Overtime Rate	
			H&W	Pension	App Tr.	Vac.	Annuity	Other	LECET (*)			MISC (*)
Classification												
Boilermaker	\$35.26		\$7.07	\$13.28	\$0.89	\$0.00	\$3.00	\$0.55	\$0.00	\$0.00	\$60.05	\$77.68
Apprentice	Percent											
1st 6 months	70.03	\$24.69	\$7.07	\$11.30	\$0.89	\$0.00	\$2.10	\$0.55	\$0.00	\$0.00	\$46.60	\$58.95
2nd 6 months	75.02	\$26.45	\$7.07	\$11.30	\$0.89	\$0.00	\$2.25	\$0.55	\$0.00	\$0.00	\$48.51	\$61.74
3rd 6 months	80.00	\$28.21	\$7.07	\$11.30	\$0.89	\$0.00	\$2.40	\$0.55	\$0.00	\$0.00	\$50.42	\$64.52
4th 6 months	85.02	\$29.98	\$7.07	\$11.30	\$0.89	\$0.00	\$2.55	\$0.55	\$0.00	\$0.00	\$52.34	\$67.33
5th 6 months	87.52	\$30.86	\$7.07	\$13.28	\$0.89	\$0.00	\$2.63	\$0.55	\$0.00	\$0.00	\$55.28	\$70.71
6th 6 months	90.03	\$31.74	\$7.07	\$13.28	\$0.89	\$0.00	\$2.70	\$0.55	\$0.00	\$0.00	\$56.23	\$72.11
7th 6 months	92.50	\$32.62	\$7.07	\$13.28	\$0.89	\$0.00	\$2.78	\$0.55	\$0.00	\$0.00	\$57.19	\$73.49
8th 6 months	95.00	\$33.50	\$7.07	\$13.28	\$0.89	\$0.00	\$2.85	\$0.55	\$0.00	\$0.00	\$58.14	\$74.89

Special Calculation Note : Other is Supplemental Health and Welfare

Ratio :

5 Journeymen to 1 Apprentice

Jurisdiction (* denotes special jurisdictional note) :

ADAMS, ATHENS, BROWN, BUTLER,
CHAMPAIGN, CLARK, CLERMONT, CLINTON,
FAIRFIELD, FAYETTE, FRANKLIN, GALLIA,
GREENE, GUERNSEY, HAMILTON, HIGHLAND,
HOCKING, JACKSON, LAWRENCE, LICKING,
MADISON, MEIGS, MIAMI, MONTGOMERY,
MORGAN, MUSKINGUM, NOBLE, PERRY,
PICKAWAY, PIKE, PREBLE, ROSS, SCIOTO,
VINTON, WARREN

Special Jurisdictional Note :

Details :

Prevailing Wage Rate Skilled Crafts

Name of Union: Boilermaker Local 154

Change # : LCN01-2012kpLoc 154

Craft : Boilermaker Effective Date : 03/22/2012 Last Posted : 03/22/2012

	BHR		Fringe Benefit Payments						Irrevocable Fund		Total PWR	Overtime Rate
			H&W	Pension	App Tr.	Vac.	Annuity	Other	LECET (*)	MISC (*)		
Classification												
Boilermaker	\$36.17		\$8.57	\$11.28	\$0.55	\$0.00	\$4.25	\$0.34	\$0.00	\$1.40	\$62.56	\$80.65
Trainee 60%	\$23.25		\$8.57	\$3.59	\$0.55	\$0.00	\$4.25	\$0.34	\$0.00	\$1.40	\$41.95	\$53.57
Trainee 70%	\$27.13		\$8.57	\$3.59	\$0.55	\$0.00	\$4.25	\$0.34	\$0.00	\$1.40	\$45.83	\$59.40
Trainee 80%	\$31.00		\$8.57	\$3.59	\$0.55	\$0.00	\$4.25	\$0.34	\$0.00	\$1.40	\$49.70	\$65.20
Trainee 90%	\$34.88		\$8.57	\$3.59	\$0.55	\$0.00	\$4.25	\$0.34	\$0.00	\$1.40	\$53.58	\$71.02
Apprentice Registered After 11/01/2005	Percent											
1st 6 months	60.00	\$21.70	\$8.57	\$3.59	\$0.55	\$0.00	\$4.25	\$0.34	\$0.00	\$1.40	\$40.40	\$51.25
2nd 6 months	65.00	\$23.51	\$8.57	\$3.59	\$0.55	\$0.00	\$4.25	\$0.34	\$0.00	\$1.40	\$42.21	\$53.97
3rd 6 months	70.00	\$25.32	\$8.57	\$3.59	\$0.55	\$0.00	\$4.25	\$0.34	\$0.00	\$1.40	\$44.02	\$56.68
4th 6 months	75.00	\$27.13	\$8.57	\$3.59	\$0.55	\$0.00	\$4.25	\$0.34	\$0.00	\$1.40	\$45.83	\$59.39
5th 6 months	80.00	\$28.94	\$8.57	\$3.59	\$0.55	\$0.00	\$4.25	\$0.34	\$0.00	\$1.40	\$47.64	\$62.10
6th 6 months	85.00	\$30.74	\$8.57	\$3.59	\$0.55	\$0.00	\$4.25	\$0.34	\$0.00	\$1.40	\$49.44	\$64.82
7th 6 months	90.00	\$32.55	\$8.57	\$3.59	\$0.55	\$0.00	\$4.25	\$0.34	\$0.00	\$1.40	\$51.25	\$67.53
8th 6 months	95.00	\$34.36	\$8.57	\$3.59	\$0.55	\$0.00	\$4.25	\$0.34	\$0.00	\$1.40	\$53.06	\$70.24

Special Calculation Note : No special calculations for this skilled craft wage rate are required at this time.

Ratio :
5 Journeymen to 1 Apprentice

Jurisdiction (* denotes special jurisdictional note) :
BUTLER, COLUMBIANA, FAYETTE, JEFFERSON,
LAWRENCE, MERCER, WARREN, WASHINGTON

Special Jurisdictional Note :

Details :

Work includes but not limited to: boiler making, acetylene burning, riveting, chipping, caulking, rigging, fitting-up, grinding, reaming, impact machine operating, unloading, and handling of boilermaker's material and equipment. Boilermakers, Blacksmiths, Forgers, Iron Shipbuilders

Prevailing Wage Rate

Skilled Crafts

Name of Union: Bricklayer Local 18

Change # : LCN01-2022sksLoc18

Craft : Bricklayer Effective Date : 06/01/2022 Last Posted : 06/01/2022

	BHR		Fringe Benefit Payments					Irrevocable Fund		Total PWR	Overtime Rate	
			H&W	Pension	App Tr.	Vac.	Annuity	Other	LECET (*)	MISC (*)		
Classification												
Bricklayer	\$31.87		\$9.55	\$6.20	\$0.68	\$0.00	\$0.00	\$0.00	\$0.00	\$0.00	\$48.30	\$64.24
Stone Mason	\$31.87		\$9.55	\$6.20	\$0.68	\$0.00	\$0.00	\$0.00	\$0.00	\$0.00	\$48.30	\$64.24
Pointer Caulker Cleaner	\$31.87		\$9.55	\$6.20	\$0.68	\$0.00	\$0.00	\$0.00	\$0.00	\$0.00	\$48.30	\$64.24
Refractory Workers	\$32.87		\$9.55	\$6.20	\$0.68	\$0.00	\$0.00	\$0.00	\$0.00	\$0.00	\$49.30	\$65.73
Refractory Worker Hot Pay	\$34.87		\$9.55	\$6.20	\$0.68	\$0.00	\$0.00	\$0.00	\$0.00	\$0.00	\$51.30	\$68.73
Sawman	\$32.12		\$9.55	\$6.20	\$0.68	\$0.00	\$0.00	\$0.00	\$0.00	\$0.00	\$48.55	\$64.61
Layout Man	\$32.12		\$9.55	\$6.20	\$0.68	\$0.00	\$0.00	\$0.00	\$0.00	\$0.00	\$48.55	\$64.61
Free Standing Chimney	\$32.37		\$9.55	\$6.20	\$0.68	\$0.00	\$0.00	\$0.00	\$0.00	\$0.00	\$48.80	\$64.98
Apprentice Percent												
1st 6 months	60.00	\$19.12	\$9.55	\$6.20	\$0.68	\$0.00	\$0.00	\$0.00	\$0.00	\$0.00	\$35.55	\$45.11
2nd 6 months	65.00	\$20.72	\$9.55	\$6.20	\$0.68	\$0.00	\$0.00	\$0.00	\$0.00	\$0.00	\$37.15	\$47.50
3rd 6 months	70.00	\$22.31	\$9.55	\$6.20	\$0.68	\$0.00	\$0.00	\$0.00	\$0.00	\$0.00	\$38.74	\$49.89
4th 6 months	75.00	\$23.90	\$9.55	\$6.20	\$0.68	\$0.00	\$0.00	\$0.00	\$0.00	\$0.00	\$40.33	\$52.28
5th 6 months	80.00	\$25.50	\$9.55	\$6.20	\$0.68	\$0.00	\$0.00	\$0.00	\$0.00	\$0.00	\$41.93	\$54.67
6th 6 months	85.00	\$27.09	\$9.55	\$6.20	\$0.68	\$0.00	\$0.00	\$0.00	\$0.00	\$0.00	\$43.52	\$57.06
7th 6 months	90.00	\$28.68	\$9.55	\$6.20	\$0.68	\$0.00	\$0.00	\$0.00	\$0.00	\$0.00	\$45.11	\$59.45
8th 6 months	95.00	\$30.28	\$9.55	\$6.20	\$0.68	\$0.00	\$0.00	\$0.00	\$0.00	\$0.00	\$46.71	\$61.84

MASON FINISHER 1st 180 Days	45.00	\$14.34	\$0.00	\$0.00	\$0.00	\$0.00	\$0.00	\$0.00	\$0.00	\$0.00	\$14.34	\$21.51
1st Year H&W after 6 months	45.00	\$14.34	\$9.55	\$0.00	\$0.00	\$0.00	\$0.00	\$0.00	\$0.00	\$0.00	\$23.89	\$31.06
2nd Year	50.00	\$15.94	\$9.55	\$0.00	\$0.00	\$0.00	\$0.00	\$0.00	\$0.00	\$0.00	\$25.48	\$33.45

Special Calculation Note : **In order to utilize a Pre-Apprentice, you must have 1 Registered Apprentice in your employ.

Ratio :

- 1-2 Journeyman to 1 Apprentice
- 3-4 Journeyman to 2 Apprentice
- 5-6 Journeyman to 2 Apprentice
- 7-10 Journeyman to 3 Apprentice

- 1 Apprentice permits 1 Mason Trainee
- 2 Apprentice permits 1 Mason Trainee
- 3 Apprentice permits 2 Mason Trainees
- 4 Apprentice permits 2 Mason Trainees

For each additional 5 Journeyman to 1 Apprentice, for every 3 additional Apprentices, 1 Mason Finisher may be added

Special Jurisdictional Note : In Preble County the following townships are included: (Dixon, Gasper, Graits, Israel, Lanier and Somers)

Details :

MASON FINISHER:duties shall be to work in all aspects of Masonry construction taking direction from the employer and the Journeyman Bricklayer & Stone Mason's working on the job. Mason Finisher's may work on job site only when a registered apprentice is on job and the ratios in table above will strictly be enforced.

Refractory work is classified as working with any of the following materials:
Acid brick, carbon black brick or carbon black block, firebrick grinding, plastics (with a gun) and any resinous cement.

Fifty cents (\$0.50) per hour above scale shall be paid to employees working on free standing industrial or institutional chimneys which are completely detached from any building structure.

Jurisdiction (* denotes special jurisdictional note) :

BROWN, BUTLER, CLERMONT, HAMILTON, PREBLE*, WARREN

Prevailing Wage Rate Skilled Crafts

Name of Union: Bricklayer Local 18 Tile Mechanic

Change # : LCN01-2022sksLoc18

Craft : Bricklayer Effective Date : 09/01/2022 Last Posted : 08/12/2022

	BHR		Fringe Benefit Payments					Irrevocable Fund		Total PWR	Overtime Rate	
			H&W	Pension	App Tr.	Vac.	Annuity	Other	LECET (*)			MISC (*)
Classification												
Bricklayer Tile Terrazzo Marble Mason Mechanic	\$31.21		\$9.67	\$5.60	\$0.57	\$0.00	\$0.00	\$0.00	\$0.00	\$0.00	\$47.05	\$62.66
Marble Layout Work	\$31.71		\$9.67	\$5.60	\$0.57	\$0.00	\$0.00	\$0.00	\$0.00	\$0.00	\$47.55	\$63.41
Swing Scaffold Worker	\$32.71		\$9.67	\$5.60	\$0.57	\$0.00	\$0.00	\$0.00	\$0.00	\$0.00	\$48.55	\$64.90
Apprentice after 2 years (2400 hrs) as Apprentice Finisher												
5th/6 Months 0- 600 hrs.	70.00	\$21.85	\$9.67	\$5.60	\$0.57	\$0.00	\$0.00	\$0.00	\$0.00	\$0.00	\$37.69	\$48.61
6th/6 months 601-1200 hrs.	80.00	\$24.97	\$9.67	\$5.60	\$0.57	\$0.00	\$0.00	\$0.00	\$0.00	\$0.00	\$40.81	\$53.29
7th/6 months 1201-1800 hrs.	85.00	\$26.53	\$9.67	\$5.60	\$0.57	\$0.00	\$0.00	\$0.00	\$0.00	\$0.00	\$42.37	\$55.63
8th/6 months 1801-2400 hrs.	90.00	\$28.09	\$9.67	\$5.60	\$0.57	\$0.00	\$0.00	\$0.00	\$0.00	\$0.00	\$43.93	\$57.97

Special Calculation Note : Classification title contains "Bricklayer" because contract originates within the Bricklayer Local.

Note that the classification description is clarified after the local union number at the top of the page.

Ratio :

1 Journeyman to 1 Apprentice
5 Journeymen to 1 Apprentice
10 Journeymen to 2 Apprentices
15 Journeymen to 3 Apprentices
20 Journeymen to 4 Apprentices
25 Journeymen to 5 Apprentices

Jurisdiction (* denotes special jurisdictional note) :

ADAMS, BROWN, BUTLER, CLERMONT, GALLIA,
HAMILTON, LAWRENCE, PREBLE*, SCIOTO,
WARREN

Special Jurisdictional Note : In Preble County the Townships of Dixon, Israel, Gasper, Lanier, Somers and Gratis.

Details :

In order to utilize a Pre-Apprentice, you must have 1 Registered Apprentice in your employ.

Prevailing Wage Rate Skilled Crafts

Name of Union: Bricklayer Local 18 Tile Finisher

Change # : LCN01-2022sksLoc18

Craft : Bricklayer Effective Date : 09/01/2022 Last Posted : 08/12/2022

	BHR		Fringe Benefit Payments					Irrevocable Fund		Total PWR	Overtime Rate	
			H&W	Pension	App Tr.	Vac.	Annuity	Other	LECET (*)			MISC (*)
Classification												
Bricklayer Tile Marble Terrazzo Finisher	\$26.66		\$9.67	\$5.60	\$0.53	\$0.00	\$0.00	\$0.00	\$0.00	\$0.00	\$42.46	\$55.79
Terrazzo Base Grinder	\$27.16		\$9.67	\$5.60	\$0.53	\$0.00	\$0.00	\$0.00	\$0.00	\$0.00	\$42.96	\$56.54
Marble Sander Polisher	\$26.76		\$9.67	\$5.60	\$0.53	\$0.00	\$0.00	\$0.00	\$0.00	\$0.00	\$42.56	\$55.94
Apprentices	Percent											
1st 6 months 0-600 hrs	65.00	\$17.33	\$9.67	\$5.60	\$0.53	\$0.00	\$0.00	\$0.00	\$0.00	\$0.00	\$33.13	\$41.79
2nd 6 months 601-1200 hrs	70.00	\$18.66	\$9.67	\$5.60	\$0.53	\$0.00	\$0.00	\$0.00	\$0.00	\$0.00	\$34.46	\$43.79
3rd 6 months 1201-1800 hrs	75.00	\$20.00	\$9.67	\$5.60	\$0.53	\$0.00	\$0.00	\$0.00	\$0.00	\$0.00	\$35.80	\$45.79
4th 6 months 1801-2400 hrs	80.00	\$21.33	\$9.67	\$5.60	\$0.53	\$0.00	\$0.00	\$0.00	\$0.00	\$0.00	\$37.13	\$47.79
5th 6 months 2401-3000 hrs	85.00	\$22.66	\$9.67	\$5.60	\$0.53	\$0.00	\$0.00	\$0.00	\$0.00	\$0.00	\$38.46	\$49.79
6th 6 months 3001-3600	95.00	\$25.33	\$9.67	\$5.60	\$0.53	\$0.00	\$0.00	\$0.00	\$0.00	\$0.00	\$41.13	\$53.79
1-30 Days Prior to Entering Apprenticeship	60.00	\$16.00	\$0.00	\$0.00	\$0.00	\$0.00	\$0.00	\$0.00	\$0.00	\$0.00	\$16.00	\$23.99

Special Calculation Note : Classification title contains "Bricklayer" because contract originates within the Bricklayer Local.

Note that the classification description is clarified after the local union number at the top of the page.

Ratio :

- 1 Journeyman to 1 Apprentice
- 5 Journeymen to 1 Apprentice
- 10 Journeymen to 2 Apprentices
- 15 Journeymen to 3 Apprentices

Jurisdiction (* denotes special jurisdictional note) :

- ADAMS, BROWN, BUTLER, CLERMONT, GALLIA, HAMILTON, LAWRENCE, PREBLE*, SCIOTO, WARREN, WARREN*

20 Journeymen to 4 Apprentices

25 Journeymen to 5 Apprentices

Special Jurisdictional Note : Warren in the townships of Dixon, Gasper, Isrsel, Somers & Gratis in Prebble County

Details :

****In order to utilize a Pre-Apprentice, you must have 1 Registerd Apprentice in your employ.****

Prevailing Wage Rate Skilled Crafts

Name of Union: Bricklayer Local 23 Heavy Hwy (A)

Change # : LCN01-2024ibLoc23HevHwyA

Craft : Bricklayer Effective Date : 06/05/2024 Last Posted : 06/05/2024

	BHR		Fringe Benefit Payments					Irrevocable Fund		Total PWR	Overtime Rate	
			H&W	Pension	App Tr.	Vac.	Annuity	Other	LECET (*)	MISC (*)		
Classification												
Cement Mason Bricklayer Sewer Water Works A	\$33.39		\$10.00	\$9.53	\$0.53	\$0.00	\$0.00	\$0.00	\$0.00	\$0.00	\$53.45	\$70.14
Apprentice	Percent											
1st year	70.00	\$23.37	\$10.00	\$9.53	\$0.53	\$0.00	\$0.00	\$0.00	\$0.00	\$0.00	\$43.43	\$55.12
2nd year	80.00	\$26.71	\$10.00	\$9.53	\$0.53	\$0.00	\$0.00	\$0.00	\$0.00	\$0.00	\$46.77	\$60.13
3rd year	90.00	\$30.05	\$10.00	\$9.53	\$0.53	\$0.00	\$0.00	\$0.00	\$0.00	\$0.00	\$50.11	\$65.14

Special Calculation Note : NOT FOR BUILDING CONSTRUCTION.

Ratio :

- 3 Journeymen to 1 Apprentice
- 6 Journeymen to 2 Apprentice
- 9 Journeymen to 3 Apprentice
- 12 Journeymen to 4 Apprentice
- 15 Journeymen to 5 Apprentice

Jurisdiction (* denotes special jurisdictional note) :

ADAMS, ALLEN, ASHLAND, ASHTABULA, ATHENS, AUGLAIZE, BELMONT, BROWN, BUTLER, CARROLL, CHAMPAIGN, CLARK, CLERMONT, CLINTON, COLUMBIANA, COSHOCTON, CRAWFORD, CUYAHOGA, DARKE, DEFIANCE, DELAWARE, ERIE, FAIRFIELD, FAYETTE, FRANKLIN, FULTON, GALLIA, GEAUGA, GREENE, GUERNSEY, HAMILTON, HANCOCK, HARDIN, HARRISON, HENRY, HIGHLAND, HOCKING, HOLMES, HURON, JACKSON, JEFFERSON, KNOX, LAKE, LAWRENCE, LICKING, LOGAN, LORAIN, LUCAS, MADISON, MAHONING, MARION, MEDINA, MEIGS, MERCER, MIAMI, MONROE, MONTGOMERY, MORGAN, MORROW, MUSKINGUM, NOBLE, OTTAWA, PAULDING, PERRY, PICKAWAY, PIKE, PORTAGE, PREBLE, PUTNAM, RICHLAND, ROSS, SANDUSKY, SCIOTO, SENECA, SHELBY, STARK, SUMMIT, TRUMBULL, TUSCARAWAS, UNION, VAN WERT, VINTON, WARREN, WASHINGTON, WAYNE

Special Jurisdictional Note :

Details :

(A) Highway Construction, Sewer, Waterworks And Utility Construction, Industrial & Building Site Heavy Construction, Airport Construction Or Railroad Construction Work.

(B) Power Plant, Tunnels, Amusement Park, Athletic Stadium Site Work ,Pollution Control,Sewer Plant, Waste Plant, & Water Treatment Facilities, Construction.

Prevailing Wage Rate Skilled Crafts

Name of Union: Bricklayer Local 23 Heavy Hwy (B)

Change # : LCN01-2024ibLoc23HevHwyB

Craft : Bricklayer Effective Date : 06/05/2024 Last Posted : 06/05/2024

	BHR		Fringe Benefit Payments					Irrevocable Fund		Total PWR	Overtime Rate	
			H&W	Pension	App Tr.	Vac.	Annuity	Other	LECET (*)			MISC (*)
Classification												
Cement Mason Bricklayer Power Plants Tunnels Amusement Parks B	\$34.39		\$10.00	\$9.52	\$0.54	\$0.00	\$0.00	\$0.00	\$0.00	\$0.00	\$54.45	\$71.65
Apprentice	Percent											
1st year	70.00	\$24.07	\$10.00	\$9.52	\$0.54	\$0.00	\$0.00	\$0.00	\$0.00	\$0.00	\$44.13	\$56.17
2nd year	80.00	\$27.51	\$10.00	\$9.52	\$0.54	\$0.00	\$0.00	\$0.00	\$0.00	\$0.00	\$47.57	\$61.33
3rd year	90.00	\$30.95	\$10.00	\$9.52	\$0.54	\$0.00	\$0.00	\$0.00	\$0.00	\$0.00	\$51.01	\$66.49

Special Calculation Note : NOT FOR BUILDING CONSTRUCTION.

Ratio :

- 3 Journeymen to 1 Apprentice
- 6 Journeymen to 2 Apprentice
- 9 Journeymen to 2 Apprentice
- 12 Journeymen to 4 Apprentice
- 15 Journeymen to 5 Apprentice

Jurisdiction (* denotes special jurisdictional note) :

ADAMS, ALLEN, ASHLAND, ASHTABULA, ATHENS, AUGLAIZE, BELMONT, BROWN, BUTLER, CARROLL, CHAMPAIGN, CLARK, CLERMONT, CLINTON, COLUMBIANA, COSHOCTON, CRAWFORD, CUYAHOGA, DARKE, DEFIANCE, DELAWARE, ERIE, FAIRFIELD, FAYETTE, FRANKLIN, FULTON, GALLIA, GEAUGA, GREENE, GUERNSEY, HAMILTON, HANCOCK, HARDIN, HARRISON, HENRY, HIGHLAND, HOCKING, HOLMES, HURON, JACKSON, JEFFERSON, KNOX, LAKE, LAWRENCE, LICKING, LOGAN, LORAIN, LUCAS, MADISON, MAHONING, MARION, MEDINA, MEIGS, MERCER, MIAMI, MONROE, MONTGOMERY, MORGAN, MORROW, MUSKINGUM, NOBLE, OTTAWA, PAULDING, PERRY, PICKAWAY, PIKE, PORTAGE, PREBLE, PUTNAM, RICHLAND, ROSS, SANDUSKY, SCIOTO, SENECA, SHELBY, STARK, SUMMIT, TRUMBULL, TUSCARAWAS, UNION, VAN WERT, VINTON, WARREN, WASHINGTON, WAYNE

Special Jurisdictional Note :

Details :
(A) Highway Construction, Sewer, Waterworks And Utility Construction, Industrial & Building Site Heavy Construction, Airport Construction Or Railroad Construction Work.

(B) Power Plant, Amusement Park, Athletic Stadium Site Work ,Pollution Control,Sewer Plant, Waste Plant, & Water Treatment Facilities, Construction.

Prevailing Wage Rate Skilled Crafts

Name of Union: Bricklayer Local 23 (Cincinnati)

Change # : LCN01-2024ibLoc23Cinci

Craft : Bricklayer Effective Date : 06/05/2024 Last Posted : 06/05/2024

	BHR		Fringe Benefit Payments						Irrevocable Fund		Total PWR	Overtime Rate
			H&W	Pension	App Tr.	Vac.	Annuity	Other	LECET (*)	MISC (*)		
Classification												
Bricklayer	\$35.00		\$9.79	\$6.64	\$0.75	\$0.00	\$0.00	\$0.00	\$0.00	\$0.00	\$52.18	\$69.68
Stone Mason	\$35.00		\$9.79	\$6.64	\$0.75	\$0.00	\$0.00	\$0.00	\$0.00	\$0.00	\$52.18	\$69.68
Pointer Caulker Cleaner	\$35.00		\$9.79	\$6.64	\$0.75	\$0.00	\$0.00	\$0.00	\$0.00	\$0.00	\$52.18	\$69.68
Refractory Workers	\$36.00		\$9.79	\$6.64	\$0.75	\$0.00	\$0.00	\$0.00	\$0.00	\$0.00	\$53.18	\$71.18
Refractory Worker Hot Pay	\$38.00		\$9.79	\$6.64	\$0.75	\$0.00	\$0.00	\$0.00	\$0.00	\$0.00	\$55.18	\$74.18
Sawman	\$35.25		\$9.79	\$6.64	\$0.75	\$0.00	\$0.00	\$0.00	\$0.00	\$0.00	\$52.43	\$70.05
Layout Man	\$35.25		\$9.79	\$6.64	\$0.75	\$0.00	\$0.00	\$0.00	\$0.00	\$0.00	\$52.43	\$70.05
Free Standing Chimney	\$35.50		\$9.79	\$6.64	\$0.75	\$0.00	\$0.00	\$0.00	\$0.00	\$0.00	\$52.68	\$70.43
Apprentice	Percent											
1st 6 months	70.00	\$24.50	\$9.79	\$6.64	\$0.75	\$0.00	\$0.00	\$0.00	\$0.00	\$0.00	\$41.68	\$53.93
2nd 6 months	74.00	\$25.90	\$9.79	\$6.64	\$0.75	\$0.00	\$0.00	\$0.00	\$0.00	\$0.00	\$43.08	\$56.03
3rd 6 months	78.00	\$27.30	\$9.79	\$6.64	\$0.75	\$0.00	\$0.00	\$0.00	\$0.00	\$0.00	\$44.48	\$58.13
4th 6 months	82.00	\$28.70	\$9.79	\$6.64	\$0.75	\$0.00	\$0.00	\$0.00	\$0.00	\$0.00	\$45.88	\$60.23
5th 6 months	86.00	\$30.10	\$9.79	\$6.64	\$0.75	\$0.00	\$0.00	\$0.00	\$0.00	\$0.00	\$47.28	\$62.33
6th 6 months	90.00	\$31.50	\$9.79	\$6.64	\$0.75	\$0.00	\$0.00	\$0.00	\$0.00	\$0.00	\$48.68	\$64.43
7th 6 months	94.00	\$32.90	\$9.79	\$6.64	\$0.75	\$0.00	\$0.00	\$0.00	\$0.00	\$0.00	\$50.08	\$66.53
8th 6 months	98.00	\$34.30	\$9.79	\$6.64	\$0.75	\$0.00	\$0.00	\$0.00	\$0.00	\$0.00	\$51.48	\$68.63
MASON FINISHER 1-90 Days	45.00	\$15.75	\$0.00	\$0.00	\$0.00	\$0.00	\$0.00	\$0.00	\$0.00	\$0.00	\$15.75	\$23.62
90-365 Days	45.00	\$15.75	\$9.79	\$0.00	\$0.00	\$0.00	\$0.00	\$0.00	\$0.00	\$0.00	\$25.54	\$33.42
366+ Days	50.00	\$17.50	\$9.79	\$0.00	\$0.00	\$0.00	\$0.00	\$0.00	\$0.00	\$0.00	\$27.29	\$36.04

Special Calculation Note : **In order to utilize a Pre-Apprentice, you must have 1 Registered Apprentice in your employ. Mason Trainees Health and Welfare after 180 days

Ratio :

- 1-2 Journeyman to 1 Apprentice
- 3-4 Journeyman to 2 Apprentice
- 5-6 Journeyman to 2 Apprentice
- 7-10 Journeyman to 3 Apprentice

Jurisdiction (* denotes special jurisdictional note) :
BROWN, BUTLER, CLERMONT, HAMILTON, PREBLE*,
WARREN

- 1 Apprentice permits 1 Mason Trainee
- 2 Apprentice permits 1 Mason Trainee
- 3 Apprentice permits 2 Mason Trainees
- 4 Apprentice permits 2 Mason Trainees

For each additional 5 Journeyman to 1 Apprentice,
for every 3 additional Apprentices, 1 Mason Finisher may be added

Special Jurisdictional Note : In Preble County the following townships are included: (Dixon, Gasper, Graits, Israel, Lanier and Somers)

Details :

MASON FINISHER:duties shall be to work in all aspects of Masonry construction taking direction from the employer and the Journeyman Bricklayer & Stone Mason's working on the job. Mason Finisher's may work on job site only when a registered apprentice is on job and the ratios in table above will strictly be enforced.

Refractory work is classified as working with any of the following materials:

Acid brick, carbon black brick or carbon black block, firebrick grinding, plastics (with a gun)
and any resinous cement.

Fifty cents (\$0.50) per hour above scale shall be paid to employees working on free standing industrial or institutional chimneys which are completely detached from any building structure.

Prevailing Wage Rate Skilled Crafts

Name of Union: Bricklayer Local 23 Tile Finisher

Change # : LCN01-2023ibLoc23TF

Craft : Bricklayer Effective Date : 09/01/2023 Last Posted : 08/30/2023

	BHR		Fringe Benefit Payments					Irrevocable Fund		Total PWR	Overtime Rate	
			H&W	Pension	App Tr.	Vac.	Annuity	Other	LECET (*)			MISC (*)
Classification												
Bricklayer Tile Marble Terrazzo Finisher	\$27.87		\$9.67	\$5.85	\$0.54	\$0.00	\$0.25	\$0.00	\$0.00	\$0.00	\$44.18	\$58.12
Terrazzo Base Grinder	\$28.37		\$9.67	\$5.85	\$0.54	\$0.00	\$0.25	\$0.00	\$0.00	\$0.00	\$44.68	\$58.87
Marble Sander Polisher	\$27.97		\$9.67	\$5.85	\$0.54	\$0.00	\$0.25	\$0.00	\$0.00	\$0.00	\$44.28	\$58.27
Apprentices												
	Percent											
1st 6 months 0-600 hrs	65.00	\$18.12	\$9.67	\$5.85	\$0.54	\$0.00	\$0.25	\$0.00	\$0.00	\$0.00	\$34.43	\$43.48
2nd 6 months 601-1200 hrs	70.00	\$19.51	\$9.67	\$5.85	\$0.54	\$0.00	\$0.25	\$0.00	\$0.00	\$0.00	\$35.82	\$45.57
3rd 6 months 1201-1800 hrs	75.00	\$20.90	\$9.67	\$5.85	\$0.54	\$0.00	\$0.25	\$0.00	\$0.00	\$0.00	\$37.21	\$47.66
4th 6 months 1801-2400 hrs	80.00	\$22.30	\$9.67	\$5.85	\$0.54	\$0.00	\$0.25	\$0.00	\$0.00	\$0.00	\$38.61	\$49.75
5th 6 months 2401-3000 hrs	85.00	\$23.69	\$9.67	\$5.85	\$0.54	\$0.00	\$0.25	\$0.00	\$0.00	\$0.00	\$40.00	\$51.84
6th 6 months 3001-3600	95.00	\$26.48	\$9.67	\$5.85	\$0.54	\$0.00	\$0.25	\$0.00	\$0.00	\$0.00	\$42.79	\$56.02
1-30 Days Prior to Entering Apprenticeship	60.00	\$16.72	\$0.00	\$0.00	\$0.00	\$0.00	\$0.00	\$0.00	\$0.00	\$0.00	\$16.72	\$25.08

Special Calculation Note : Classification title contains "Bricklayer" because contract originates within the Bricklayer Local.

Note that the classification description is clarified after the local union number at the top of the page.

Ratio :

- 1 Journeyman to 1 Apprentice
- 5 Journeymen to 1 Apprentice
- 10 Journeymen to 2 Apprentices
- 15 Journeymen to 3 Apprentices

Jurisdiction (* denotes special jurisdictional note) :

- ADAMS, BROWN, BUTLER, CLERMONT, GALLIA, HAMILTON, LAWRENCE, PREBLE*, SCIOTO, WARREN, WARREN*

20 Journeymen to 4 Apprentices
25 Journeymen to 5 Apprentices

Special Jurisdictional Note : Warren in the townships of Dixon, Gasper, Isrsel, Somers & Gratis in Prebble County

Details :

****In order to utilize a Pre-Apprentice, you must have 1 Registerd Apprentice in your employ.****

Prevailing Wage Rate Skilled Crafts

Name of Union: Bricklayer Local 23 Tile Mechanic

Change # : LCN01-2023ibLoc23TM

Craft : Bricklayer Effective Date : 09/01/2023 Last Posted : 08/30/2023

	BHR		Fringe Benefit Payments						Irrevocable Fund		Total PWR	Overtime Rate
			H&W	Pension	App Tr.	Vac.	Annuity	Other	LECET (*)	MISC (*)		
Classification												
Bricklayer Tile Terrazzo Marble Mason Mechanic	\$32.41		\$9.67	\$5.85	\$0.57	\$0.00	\$0.25	\$0.00	\$0.00	\$0.00	\$48.75	\$64.95
Marble Layout Work	\$32.91		\$9.67	\$5.85	\$0.57	\$0.00	\$0.25	\$0.00	\$0.00	\$0.00	\$49.25	\$65.70
Swing Scaffold Worker	\$33.91		\$9.67	\$5.85	\$0.57	\$0.00	\$0.25	\$0.00	\$0.00	\$0.00	\$50.25	\$67.20
Apprentice after 2 years (2400 hrs) as Apprentice Finisher	Percent											
5th/6 Months 0- 600 hrs	70.00	\$22.69	\$9.67	\$5.85	\$0.57	\$0.00	\$0.25	\$0.00	\$0.00	\$0.00	\$39.03	\$50.37
6th/6 months 601-1200 hrs	80.00	\$25.93	\$9.67	\$5.85	\$0.57	\$0.00	\$0.25	\$0.00	\$0.00	\$0.00	\$42.27	\$55.23
7th/6 months 1201-1800 hrs.	85.00	\$27.55	\$9.67	\$5.85	\$0.57	\$0.00	\$0.25	\$0.00	\$0.00	\$0.00	\$43.89	\$57.66
8th/6 months 1801-2400 hrs.	90.00	\$29.17	\$9.67	\$5.85	\$0.57	\$0.00	\$0.25	\$0.00	\$0.00	\$0.00	\$45.51	\$60.09

Special Calculation Note : Classification title contains "Bricklayer" because contract originates within the Bricklayer Local.

Note that the classification description is clarified after the local union number at the top of the page.

Ratio :

1 Journeyman to 1 Apprentice
5 Journeymen to 1 Apprentice
10 Journeymen to 2 Apprentices
15 Journeymen to 3 Apprentices
20 Journeymen to 4 Apprentices
25 Journeymen to 5 Apprentices

Jurisdiction (* denotes special jurisdictional note) :

ADAMS, BROWN, BUTLER, CLERMONT, GALLIA,
HAMILTON, LAWRENCE, PREBLE*, SCIOTO,
WARREN

Special Jurisdictional Note : In Preble County the Townships of Dixon, Israel, Gasper, Lanier, Somers and Gratis.

Details :

****In order to utilize a Pre-Apprentice, you must have 1 Registered Apprentice in your employ.****

Prevailing Wage Rate

Skilled Crafts

Name of Union: Carpenter & Pile Driver SW District HevHwy

Change # : LCR01-2024ibCarpSWHevHwy

Craft : Carpenter Effective Date : 05/03/2024 Last Posted : 05/03/2024

	BHR		Fringe Benefit Payments					Irrevocable Fund		Total PWR	Overtime Rate	
			H&W	Pension	App Tr.	Vac.	Annuity	Other	LECET (*)			MISC (*)
Classification												
Journeyman	\$34.25		\$8.57	\$6.95	\$0.60	\$0.00	\$5.06	\$0.16	\$0.00	\$0.00	\$55.59	\$72.71
Apprentice	Percent											
1st 6 Months	60.00	\$20.55	\$8.57	\$6.95	\$0.60	\$0.00	\$5.06	\$0.16	\$0.00	\$0.00	\$41.89	\$52.17
2nd 6 Months	65.00	\$22.26	\$8.57	\$6.95	\$0.60	\$0.00	\$5.06	\$0.16	\$0.00	\$0.00	\$43.60	\$54.73
3rd 6 Months	70.02	\$23.98	\$8.57	\$6.95	\$0.60	\$0.00	\$5.06	\$0.16	\$0.00	\$0.00	\$45.32	\$57.31
4th 6 Months	75.00	\$25.69	\$8.57	\$6.95	\$0.60	\$0.00	\$5.06	\$0.16	\$0.00	\$0.00	\$47.03	\$59.87
5th 6 Months	80.00	\$27.40	\$8.57	\$6.95	\$0.60	\$0.00	\$5.06	\$0.16	\$0.00	\$0.00	\$48.74	\$62.44
6th 6 Months	85.00	\$29.11	\$8.57	\$6.95	\$0.60	\$0.00	\$5.06	\$0.16	\$0.00	\$0.00	\$50.45	\$65.01
7th 6 Months	90.02	\$30.83	\$8.57	\$6.95	\$0.60	\$0.00	\$5.06	\$0.16	\$0.00	\$0.00	\$52.17	\$67.59
8th 6 Months	95.00	\$32.54	\$8.57	\$6.95	\$0.60	\$0.00	\$5.06	\$0.16	\$0.00	\$0.00	\$53.88	\$70.15

Special Calculation Note : Other is UBC National Fund.

Ratio :

1 Journeyman to 1 Apprentice

An employer shall have the right to employ one (1) Apprentice for one (1) Journeyman Carpenter in its employment for the first Apprentice employed, and 1 (1) Apprentice for two (2) Journeyman Carpenter for additional Apprentices employed.

Thereafter, every third additional carpenter hired shall be an apprentice, if available, and if practical for the type of work being performed.

Jurisdiction (* denotes special jurisdictional note) :

BROWN, BUTLER, CHAMPAIGN, CLARK, CLERMONT, CLINTON, DARKE, GREENE, HAMILTON, LOGAN, MIAMI, MONTGOMERY, PREBLE, SHELBY, WARREN

Special Jurisdictional Note :

Details :

Highway Construction, Airport Construction, Heavy Construction but not limited to:(tunnels,subways,drainage projects,flood control,reservoirs). Railroad Construction,Sewer Waterworks & Utility Construction but not limited to: (storm sewers, waterlines, gaslines). Industrial & Building Site, Power Plant, Amusement Park, Athletic Stadium Site, Sewer and Water Plants.

When the Contractor furnishes the necessary underwater gear for the Diver, the Diver shall be paid one and one half (1&1/2) times the journeyman rate for the time spent in the water.

Prevailing Wage Rate Skilled Crafts

Name of Union: Carpenter & Pile Driver
SW Zone 2

Change # : LCN01-2023ibLoc2SWZone2

Craft : Carpenter Effective Date : 06/07/2023 Last Posted : 06/07/2023

	BHR		Fringe Benefit Payments					Irrevocable Fund		Total PWR	Overtime Rate	
			H&W	Pension	App Tr.	Vac.	Annuity	Other	LECET (*)			MISC (*)
Classification												
Carpenter	\$30.22		\$8.00	\$6.95	\$0.60	\$0.00	\$2.60	\$0.15	\$0.00	\$0.00	\$48.52	\$63.63
Pile Driver	\$30.22		\$8.00	\$6.95	\$0.60	\$0.00	\$2.60	\$0.15	\$0.00	\$0.00	\$48.52	\$63.63
Apprentice	Percent											
1st 3 Months	60.00	\$18.13	\$0.00	\$0.00	\$0.00	\$0.00	\$0.00	\$0.00	\$0.00	\$0.00	\$18.13	\$27.20
2nd 3 Months	60.00	\$18.13	\$8.00	\$0.00	\$0.60	\$0.00	\$2.60	\$0.15	\$0.00	\$0.00	\$29.48	\$38.55
2nd 6 Months	60.00	\$18.13	\$8.00	\$0.00	\$0.60	\$0.00	\$2.60	\$0.15	\$0.00	\$0.00	\$29.48	\$38.55
3rd 6 Months	65.00	\$19.64	\$8.00	\$0.00	\$0.60	\$0.00	\$2.60	\$0.15	\$0.00	\$0.00	\$30.99	\$40.81
4th 6 Months	65.00	\$19.64	\$8.00	\$0.00	\$0.60	\$0.00	\$2.60	\$0.15	\$0.00	\$0.00	\$30.99	\$40.81
5th 6 Months	70.00	\$21.15	\$8.00	\$6.95	\$0.60	\$0.00	\$2.60	\$0.15	\$0.00	\$0.00	\$39.45	\$50.03
6th 6 Months	75.00	\$22.66	\$8.00	\$6.95	\$0.60	\$0.00	\$2.60	\$0.15	\$0.00	\$0.00	\$40.97	\$52.30
7th 6 Months	80.00	\$24.18	\$8.00	\$6.95	\$0.60	\$0.00	\$2.60	\$0.15	\$0.00	\$0.00	\$42.48	\$54.56
8th 6 Months	85.00	\$25.69	\$8.00	\$6.95	\$0.60	\$0.00	\$2.60	\$0.15	\$0.00	\$0.00	\$43.99	\$56.83

Special Calculation Note : Other is for UBC National Fund.

Ratio :

4 Journeyman to 1 Apprentice

Jurisdiction (* denotes special jurisdictional note) :

BROWN, BUTLER, CLERMONT, CLINTON, HAMILTON, WARREN

Special Jurisdictional Note :

Details :

Carpenter duties shall include but not limited to: Pile driving, milling, fashioning, joining, assembling, erecting, fastening, or dismantling of all material of

wood, plastic, metal, fiber, cork, and composition, and all other substitute materials: pile driving, cutting, fitting, and placing of lagging, and the handling, cleaning, erecting, installing, and dismantling of machinery, equipment, and erecting pre-engineered metal buildings.

Pile Drivers work but not limited to: unloading, assembling, erection, repairs, operation, signaling, dismantling, and reloading all equipment that is used for pile driving including pile butts. pile butts is defined as sheeting or scrap piling. Underwater work that may be required in connection with the installation of piling. The diver and his tender work as a team and shall arrive at their own financial arrangements with the contractor. Any configuration of wood, steel, concrete, or composite that is jetted, driven, or vibrated onto the ground by conventional pile driving equipment for the purpose of supporting a future load that may be permanent or temporary.

Driving bracing, plumbing, cutting off and capping of all piling whether wood, metal, pipe piling or composite. Loading, unloading, erecting, framing, dismantling, moving, and handling of pile driving equipment. piling used in the construction and repair of all wharves, docks, piers, trestles, caissons, cofferdams, and the erection of all sea walls and breakwaters. All underwater and marine work on bulkheads, wharves, docks, shipyards, caissons, piers, bridges, pipeline work, viaducts, marine cable and trestles, as well as salvage and reclamation work where divers are employed.

Rate shall include carpenters, acoustic, and ceiling installers, drywall installers, pile drivers, and floorlayers.

Prevailing Wage Rate Skilled Crafts

Name of Union: Carpenter Floorlayer SW District G

Change # : LCN01-2023ibLocSWG

Craft : Carpenter Effective Date : 09/20/2023 Last Posted : 09/20/2023

	BHR		Fringe Benefit Payments					Irrevocable Fund		Total PWR	Overtime Rate	
			H&W	Pension	App Tr.	Vac.	Annuity	Other	LECET (*)			MISC (*)
Classification												
Carpenter Floorlayer	\$29.02		\$8.31	\$6.95	\$0.60	\$0.00	\$2.28	\$0.15	\$0.00	\$0.00	\$47.31	\$61.82
Apprentice	Percent											
1st 3 months	65.00	\$18.86	\$0.00	\$0.00	\$0.00	\$0.00	\$0.00	\$0.00	\$0.00	\$0.00	\$18.86	\$28.29
2nd 3 months	65.00	\$18.86	\$8.31	\$0.00	\$0.60	\$0.00	\$2.28	\$0.15	\$0.00	\$0.00	\$30.20	\$39.63
2nd 6 months	65.00	\$18.86	\$8.31	\$0.00	\$0.60	\$0.00	\$2.28	\$0.15	\$0.00	\$0.00	\$30.20	\$39.63
3rd 6 months	70.00	\$20.31	\$8.31	\$0.00	\$0.60	\$0.00	\$2.28	\$0.15	\$0.00	\$0.00	\$31.65	\$41.81
4th 6 months	75.00	\$21.76	\$8.31	\$0.00	\$0.60	\$0.00	\$2.28	\$0.15	\$0.00	\$0.00	\$33.11	\$43.99
5th 6 months	80.00	\$23.22	\$8.31	\$6.95	\$0.60	\$0.00	\$2.28	\$0.15	\$0.00	\$0.00	\$41.51	\$53.11
6th 6 months	85.00	\$24.67	\$8.31	\$6.95	\$0.60	\$0.00	\$2.28	\$0.15	\$0.00	\$0.00	\$42.96	\$55.29
7th 6 months	90.00	\$26.12	\$8.31	\$6.95	\$0.60	\$0.00	\$2.28	\$0.15	\$0.00	\$0.00	\$44.41	\$57.47
8th 6 months	95.00	\$27.57	\$8.31	\$6.95	\$0.60	\$0.00	\$2.28	\$0.15	\$0.00	\$0.00	\$45.86	\$59.64

Special Calculation Note : Other fs for UBC National Fund and Install

Ratio :

1 Journeymen to 1 Apprentice

Jurisdiction (* denotes special jurisdictional note) :

BROWN, BUTLER, CHAMPAIGN, CLARK, CLERMONT, CLINTON, DARKE, GREENE, HAMILTON, LOGAN, MIAMI, MONTGOMERY, PREBLE, SHELBY, WARREN

Special Jurisdictional Note :

Details :

Scope of work shall include, but not be limited to: receiving,unloading,handling,distribution and installation of all carpeting materials,carpet padding or matting materials and all resilient materials whether for use on walls,

floors, counter, sink, table and all preparation work necessary in connection therewith, including sanding work. the installation of nonstructural under-layment and the work of removing, cleaning waxing of any of the above. Carpeting shall include any floor covering composed of either natural or synthetic fibers that are made in breadths to be sewed, fastened or directly glued to floors or over cushioning sound-proofing materials. Resilient Floors shall consist of and include the laying of all special designs of wood, wood block, wood composition, cork, linoleum, asphalt, mastic, plastic, rubber tile, whether nailed or glued.

Prevailing Wage Rate Skilled Crafts

Name of Union: Carpenter Millwright Local 1090 SW Zone I

Change # : LCN01-2023ibLoc1090SWZ1

Craft : Carpenter Effective Date : 09/20/2023 Last Posted : 09/20/2023

	BHR		Fringe Benefit Payments						Irrevocable Fund		Total PWR	Overtime Rate
			H&W	Pension	App Tr.	Vac.	Annuity	Other	LECET (*)	MISC (*)		
Classification												
Carpenter Millwright	\$34.45		\$8.13	\$6.95	\$0.62	\$0.00	\$7.57	\$0.18	\$0.00	\$0.00	\$57.90	\$75.13
Apprentice	Percent											
1st 6 months	60.00	\$20.67	\$8.13	\$4.27	\$0.62	\$0.00	\$4.54	\$0.18	\$0.00	\$0.00	\$38.41	\$48.75
2nd 6 months	65.00	\$22.39	\$8.13	\$4.61	\$0.62	\$0.00	\$4.92	\$0.18	\$0.00	\$0.00	\$40.85	\$52.05
3rd 6 months	70.00	\$24.12	\$8.13	\$4.94	\$0.62	\$0.00	\$5.30	\$0.18	\$0.00	\$0.00	\$43.28	\$55.34
4th 6 months	75.00	\$25.84	\$8.13	\$5.28	\$0.62	\$0.00	\$5.68	\$0.18	\$0.00	\$0.00	\$45.73	\$58.65
5th 6 months	80.00	\$27.56	\$8.13	\$5.61	\$0.62	\$0.00	\$6.06	\$0.18	\$0.00	\$0.00	\$48.16	\$61.94
6th 6 months	85.00	\$29.28	\$8.13	\$5.95	\$0.62	\$0.00	\$6.43	\$0.18	\$0.00	\$0.00	\$50.59	\$65.23
7th 6 months	90.00	\$31.01	\$8.13	\$6.28	\$0.62	\$0.00	\$6.81	\$0.18	\$0.00	\$0.00	\$53.03	\$68.53
8th 6 months	95.00	\$32.73	\$8.13	\$6.62	\$0.62	\$0.00	\$7.19	\$0.18	\$0.00	\$0.00	\$55.47	\$71.83

Special Calculation Note : Other (\$0.18) \$0.13 National Fund and National Millwright Fund \$0.05

Ratio :

3 Journeymen to 1 Apprentice

Jurisdiction (* denotes special jurisdictional note) :

BROWN, BUTLER, CLERMONT, CLINTON, HAMILTON, WARREN

Special Jurisdictional Note :

Details :

Prevailing Wage Rate Skilled Crafts

Name of Union: Carpenter NE District Industrial Dock & Door

Change # : LCN01-2014fbCarpNEStatewide

Craft : Carpenter Effective Date : 03/05/2014 Last Posted : 03/05/2014

	BHR		Fringe Benefit Payments					Irrevocable Fund		Total PWR	Overtime Rate	
			H&W	Pension	App Tr.	Vac.	Annuity	Other	LECET (*)			MISC (*)
Classification												
Carpenter	\$19.70		\$5.05	\$1.00	\$0.15	\$0.00	\$0.00	\$0.00	\$0.00	\$0.00	\$25.90	\$35.75
Trainee												
Percent												
1st Year	60.00	\$11.82	\$5.05	\$1.00	\$0.15	\$0.00	\$0.00	\$0.00	\$0.00	\$0.00	\$18.02	\$23.93
2nd Year	80.20	\$15.80	\$5.05	\$1.00	\$0.15	\$0.00	\$0.00	\$0.00	\$0.00	\$0.00	\$22.00	\$29.90

Special Calculation Note : No special calculations for this skilled craft wage rate are required at this time.

Ratio :

1 Journeymen to 1 Trainee

Jurisdiction (* denotes special jurisdictional note) :

ADAMS, ALLEN, ASHLAND, ASHTABULA, ATHENS, AUGLAIZE, BELMONT, BROWN, BUTLER, CARROLL, CHAMPAIGN, CLARK, CLERMONT, CLINTON, COLUMBIANA, COSHOCTON, CRAWFORD, CUYAHOGA, DARKE, DEFIANCE, DELAWARE, ERIE, FAIRFIELD, FAYETTE, FRANKLIN, FULTON, GALLIA, GEAUGA, GREENE, GUERNSEY, HAMILTON, HANCOCK, HARDIN, HARRISON, HENRY, HIGHLAND, HOCKING, HOLMES, HURON, JACKSON, JEFFERSON, KNOX, LAKE, LAWRENCE, LICKING, LOGAN, LORAIN, LUCAS, MADISON, MAHONING, MARION, MEDINA, MEIGS, MERCER, MIAMI, MONROE, MONTGOMERY, MORGAN, MORROW, MUSKINGUM, NOBLE, OTTAWA, PAULDING, PERRY, PICKAWAY, PIKE, PORTAGE, PREBLE, PUTNAM, RICHLAND, ROSS, SANDUSKY, SCIOTO, SENECA, SHELBY, STARK, SUMMIT, TRUMBULL, TUSCARAWAS, UNION, VAN WERT, VINTON, WARREN, WASHINGTON, WAYNE, WILLIAMS, WOOD, WYANDOT

Special Jurisdictional Note : Industrial Dock and Door is the installation of overhead doors, roll up doors and dock leveling equipment

Details :

10/27/10 New Contract jc

Prevailing Wage Rate Skilled Crafts

Name of Union: Cement Mason Bricklayer Local 97 HevHwy A

Change # : LCN01-2021fbHvyHwy

Craft : Bricklayer Effective Date : 06/01/2021 Last Posted : 05/26/2021

	BHR		Fringe Benefit Payments					Irrevocable Fund		Total PWR	Overtime Rate	
			H&W	Pension	App Tr.	Vac.	Annuity	Other	LECET (*)			MISC (*)
Classification												
Cement Mason Bricklayer Sewer Water Works A	\$30.40		\$9.50	\$7.57	\$0.48	\$0.00	\$0.00	\$0.00	\$0.00	\$0.00	\$47.95	\$63.15
Apprentice	Percent											
1st year	50.00	\$15.20	\$9.50	\$7.57	\$0.48	\$0.00	\$0.00	\$0.00	\$0.00	\$0.00	\$32.75	\$40.35
2nd year	70.00	\$21.28	\$9.50	\$7.57	\$0.48	\$0.00	\$0.00	\$0.00	\$0.00	\$0.00	\$38.83	\$49.47
3rd year	90.00	\$27.36	\$9.50	\$7.57	\$0.48	\$0.00	\$0.00	\$0.00	\$0.00	\$0.00	\$44.91	\$58.59

Special Calculation Note : NOT FOR BUILDING CONSTRUCTION.

Ratio :

- 3 Journeymen to 1 Apprentice
- 6 Journeymen to 2 Apprentice
- 9 Journeymen to 3 Apprentice
- 12 Journeymen to 4 Apprentice
- 15 Journeymen to 5 Apprentice

Jurisdiction (* denotes special jurisdictional note) :

ADAMS, ALLEN, ASHLAND, ASHTABULA, ATHENS, AUGLAIZE, BELMONT, BROWN, BUTLER, CARROLL, CHAMPAIGN, CLARK, CLERMONT, CLINTON, COLUMBIANA, COSHOCTON, CRAWFORD, CUYAHOGA, DARKE, DEFIANCE, DELAWARE, ERIE, FAIRFIELD, FAYETTE, FRANKLIN, FULTON, GALLIA, GEAUGA, GREENE, GUERNSEY, HAMILTON, HANCOCK, HARDIN, HARRISON, HENRY, HIGHLAND, HOCKING, HOLMES, HURON, JACKSON, JEFFERSON, KNOX, LAKE, LAWRENCE, LICKING, LOGAN, LORAIN, LUCAS, MADISON, MAHONING, MARION, MEDINA, MEIGS, MERCER, MIAMI, MONROE, MONTGOMERY, MORGAN, MORROW, MUSKINGUM, NOBLE, OTTAWA, PAULDING, PERRY, PICKAWAY, PIKE, PORTAGE, PREBLE, PUTNAM, RICHLAND, ROSS, SANDUSKY, SCIOTO, SENECA, SHELBY, STARK, SUMMIT, TRUMBULL, TUSCARAWAS, UNION, VAN WERT, VINTON, WARREN, WASHINGTON, WAYNE

Special Jurisdictional Note :

Details :

(A) Highway Construction, Sewer, Waterworks And Utility Construction, Industrial & Building Site Heavy Construction, Airport Construction Or Railroad Construction Work.

(B) Power Plant, Tunnels, Amusement Park, Athletic Stadium Site Work ,Pollution Control,Sewer Plant, Waste Plant, & Water Treatment Facilities, Construction.

Prevailing Wage Rate Skilled Crafts

Name of Union: Cement Mason Bricklayer Local 97 HevHwy B

Change # : LCN01-2021fbHvyHwy

Craft : Bricklayer Effective Date : 06/01/2021 Last Posted : 05/26/2021

	BHR		Fringe Benefit Payments						Irrevocable Fund		Total PWR	Overtime Rate
			H&W	Pension	App Tr.	Vac.	Annuity	Other	LECET (*)	MISC (*)		
Classification												
Cement Mason Bricklayer Power Plants Tunnels Amusement Parks B	\$31.39		\$9.50	\$7.57	\$0.49	\$0.00	\$0.00	\$0.00	\$0.00	\$0.00	\$48.95	\$64.64
Apprentice	Percent											
1st year	50.00	\$15.70	\$9.50	\$7.57	\$0.49	\$0.00	\$0.00	\$0.00	\$0.00	\$0.00	\$33.26	\$41.10
2nd year	70.00	\$21.97	\$9.50	\$7.57	\$0.49	\$0.00	\$0.00	\$0.00	\$0.00	\$0.00	\$39.53	\$50.52
3rd year	90.00	\$28.25	\$9.50	\$7.57	\$0.49	\$0.00	\$0.00	\$0.00	\$0.00	\$0.00	\$45.81	\$59.94

Special Calculation Note : NOT FOR BUILDING CONSTRUCTION.

Ratio :

- 3 Journeymen to 1 Apprentice
- 6 Journeymen to 2 Apprentice
- 9 Journeymen to 2 Apprentice
- 12 Journeymen to 4 Apprentice
- 15 Journeymen to 5 Apprentice

Jurisdiction (* denotes special jurisdictional note) :

ADAMS, ALLEN, ASHLAND, ASHTABULA, ATHENS, AUGLAIZE, BELMONT, BROWN, BUTLER, CARROLL, CHAMPAIGN, CLARK, CLERMONT, CLINTON, COLUMBIANA, COSHOCTON, CRAWFORD, CUYAHOGA, DARKE, DEFIANCE, DELAWARE, ERIE, FAIRFIELD, FAYETTE, FRANKLIN, FULTON, GALLIA, GEAUGA, GREENE, GUERNSEY, HAMILTON, HANCOCK, HARDIN, HARRISON, HENRY, HIGHLAND, HOCKING, HOLMES, HURON, JACKSON, JEFFERSON, KNOX, LAKE, LAWRENCE, LICKING, LOGAN, LORAIN, LUCAS, MADISON, MAHONING, MARION, MEDINA, MEIGS, MERCER, MIAMI, MONROE, MONTGOMERY, MORGAN, MORROW, MUSKINGUM, NOBLE, OTTAWA, PAULDING, PERRY, PICKAWAY, PIKE, PORTAGE, PREBLE, PUTNAM, RICHLAND, ROSS, SANDUSKY, SCIOTO, SENECA, SHELBY, STARK, SUMMIT,

Special Jurisdictional Note :

Details :

(A) Highway Construction, Sewer, Waterworks And Utility Construction, Industrial & Building Site Heavy Construction, Airport Construction Or Railroad Construction Work.

(B) Power Plant, Tunnels, Amusement Park, Athletic Stadium Site Work ,Pollution Control,Sewer Plant, Waste Plant, & Water Treatment Facilities, Construction.

Prevailing Wage Rate

Skilled Crafts

Name of Union: Cement Mason Statewide HevHwy

Change # : LCN01-2024ibCementHevHwy

Craft : Cement Mason Effective Date : 05/01/2024 Last Posted : 05/01/2024

	BHR		Fringe Benefit Payments						Irrevocable Fund		Total PWR	Overtime Rate
			H&W	Pension	App Tr.	Vac.	Annulity	Other	LECET (*)	MISC (*)		
Classification												
Cement Mason	\$34.74		\$8.80	\$7.65	\$0.75	\$0.00	\$2.25	\$0.07	\$0.00	\$0.00	\$54.26	\$71.63
Apprentice	Percent											
1st Year	70.00	\$24.32	\$8.80	\$7.65	\$0.75	\$0.00	\$2.25	\$0.07	\$0.00	\$0.00	\$43.84	\$56.00
2nd Year	80.00	\$27.79	\$8.80	\$7.65	\$0.75	\$0.00	\$2.25	\$0.07	\$0.00	\$0.00	\$47.31	\$61.21
3rd Year	90.00	\$31.27	\$8.80	\$7.65	\$0.75	\$0.00	\$2.25	\$0.07	\$0.00	\$0.00	\$50.79	\$66.42
4th Year	95.00	\$33.00	\$8.80	\$7.65	\$0.75	\$0.00	\$3.25	\$0.07	\$0.00	\$0.00	\$53.52	\$70.02

Special Calculation Note : Other \$0.07 is for International Training Fund

4th Year Apprentice Rate (95%) is only applicable to the jurisdiction of Local 404, this includes Ashtabula, Cuyahoga, Geauga, Lake, and Lorain counties.

Ratio :

1 Journeymen to 1 Apprentice
2 to 1 thereafter

Jurisdiction (* denotes special jurisdictional note) :

ADAMS, ALLEN, ASHLAND, ASHTABULA*, ATHENS, AUGLAIZE, BELMONT, BROWN, BUTLER, CARROLL, CHAMPAIGN, CLARK, CLERMONT, CLINTON, COLUMBIANA, COSHOCTON, CRAWFORD, CUYAHOGA*, DARKE, DEFIANCE, DELAWARE, ERIE, FAIRFIELD, FAYETTE, FRANKLIN, FULTON*, GALLIA, GEAUGA*, GREENE, GUERNSEY, HAMILTON, HANCOCK*, HARDIN, HARRISON, HENRY*, HIGHLAND, HOCKING, HOLMES, HURON, JACKSON, JEFFERSON, KNOX, LAKE*, LAWRENCE, LICKING, LOGAN, LORAIN, LUCAS*, MADISON, MAHONING, MARION, MEDINA, MEIGS, MERCER, MIAMI, MONROE, MONTGOMERY, MORGAN, MORROW, MUSKINGUM, NOBLE, OTTAWA, PAULDING, PERRY, PICKAWAY, PIKE, PORTAGE, PREBLE, PUTNAM*, RICHLAND, ROSS, SANDUSKY, SCIOTO, SENECA, SHELBY, STARK, SUMMIT, TRUMBULL, TUSCARAWAS, UNION, VAN WERT, VINTON, WARREN, WASHINGTON, WAYNE, WILLIAMS, WOOD*, WYANDOT

Special Jurisdictional Note : (A) Highway Construction, Sewer, Waterworks And Utility Construction, Industrial & Building Site, Heavy

Construction, Airport Construction Or Railroad Construction Work, Power Plant, Tunnels, Amusement Park, Athletic Stadium Site Work, Pollution Control, Sewer Plant, Waste & Water Plant, Water Treatment Facilities Construction.

*For Power Plant, Tunnels, Amusement Park, Athletic Stadium Site Work, Pollution Control, Sewer Plant, Waste & Water Plant, Water Treatment Facility Construction work in the following Counties: Ashtabula, Cuyahoga, Fulton, Geauga, Hancock, Henry, Lake, Lucas, Putnam and Wood Counties, those counties will use the Cement Mason Statewide Heavy Highway Exhibit B District 1 Wage Rate.

Details :

This rate replaces the previous Cement Mason Heavy Highway Statewide Rates (Exhibit A and Exhibit B rates), except for Cement Mason Statewide Heavy Highway Exhibit B Dist 1. sks

Construction, Airport Construction Or Railroad Construction Work, Power Plant, Tunnels, Amusement Park, Athletic Stadium Site Work, Pollution Control, Sewer Plant, Waste & Water Plant, Water Treatment Facilities Construction.

*For Power Plant, Tunnels, Amusement Park, Athletic Stadium Site Work, Pollution Control, Sewer Plant, Waste & Water Plant, Water Treatment Facility Construction work in the following Counties: Ashtabula, Cuyahoga, Fulton, Geauga, Hancock, Henry, Lake, Lucas, Putnam and Wood Counties, those counties will use the Cement Mason Statewide Heavy Highway Exhibit B District 1 Wage Rate.

Details :

This rate replaces the previous Cement Mason Heavy Highway Statewide Rates (Exhibit A and Exhibit B rates), except for Cement Mason Statewide Heavy Highway Exhibit B Dist 1. sks

Prevailing Wage Rate Skilled Crafts

Name of Union: Cement Mason Local 132 (Cincinnati)

Change # : LCN01-2024ibLoc132

Craft : Cement Effective Date : 06/05/2024 Last Posted : 06/05/2024

	BHR		Fringe Benefit Payments					Irrevocable Fund		Total PWR	Overtime Rate	
			H&W	Pension	App Tr.	Vac.	Annuity	Other	LECET (*)			MISC (*)
Classification												
Cement Mason	\$32.00		\$8.00	\$6.50	\$0.75	\$0.00	\$0.44	\$0.06	\$0.00	\$0.00	\$47.75	\$63.75
Apprentice	Percent											
1st Year	70.00	\$22.40	\$8.00	\$6.50	\$0.75	\$0.00	\$0.44	\$0.06	\$0.00	\$0.00	\$38.15	\$49.35
2nd Year	80.00	\$25.60	\$8.00	\$6.50	\$0.75	\$0.00	\$0.44	\$0.06	\$0.00	\$0.00	\$41.35	\$54.15
3rd Year	90.00	\$28.80	\$8.00	\$6.50	\$0.75	\$0.00	\$0.44	\$0.06	\$0.00	\$0.00	\$44.55	\$58.95

Special Calculation Note : Other: International Training Fund

Ratio :

- 1 Journeyman to 1 Apprentice
- 4 Journeymen to 2 Apprentices
- 7 Journeymen to 3 Apprentices
- 10 Journeymen to 4 Apprentices

Jurisdiction (* denotes special jurisdictional note) :

BROWN, BUTLER, CLERMONT, HAMILTON, HIGHLAND, WARREN

Special Jurisdictional Note :

Details :

- *Cement Masons working on silo & slip form work shall receive \$.50 per hour over Journeyman scale.
- *Cement Masons working on swinging scaffolds shall receive \$.50 per hour over Journeyman scale.
- *Cement Masons working on high lifts from 20' and above shall receive \$.50 per hour over Journeyman scale.

Prevailing Wage Rate Skilled Crafts

Name of Union: Cement Mason Statewide HevHwy Exhibit A District II

Change # : OCN01-2021fbCementHevHwy

Craft : Cement Mason Effective Date : 05/01/2021 Last Posted : 04/23/2021

	BHR		Fringe Benefit Payments						Irrevocable Fund		Total PWR	Overtime Rate
			H&W	Pension	App Tr.	Vac.	Annuity	Other	LECET (*)	MISC (*)		
Classification												
Cement Mason	\$31.15		\$8.25	\$7.35	\$0.65	\$0.00	\$2.25	\$0.07	\$0.00	\$0.00	\$49.72	\$65.29
Apprentice	Percent											
1st Year	70.00	\$21.80	\$8.25	\$7.35	\$0.65	\$0.00	\$2.25	\$0.07	\$0.00	\$0.00	\$40.37	\$51.28
2nd Year	80.00	\$24.92	\$8.25	\$7.35	\$0.65	\$0.00	\$2.25	\$0.07	\$0.00	\$0.00	\$43.49	\$55.95
3rd Year	90.00	\$28.03	\$8.25	\$7.35	\$0.65	\$0.00	\$2.25	\$0.07	\$0.00	\$0.00	\$46.60	\$60.62

Special Calculation Note : Other \$0.07 is for International Training Fund

Ratio :

1 Journeymen to 1 Apprentice
2 to 1 thereafter

Jurisdiction (* denotes special jurisdictional note) :

ALLEN, AUGLAIZE, BROWN, BUTLER, CARROLL, CLERMONT, COLUMBIANA, DEFIANCE, ERIE, HAMILTON, HARDIN, HIGHLAND, HOLMES, HURON, LOGAN, LORAIN, MAHONING, MEDINA, MERCER, OTTAWA, PAULDING, PORTAGE, SANDUSKY, SENECA, STARK, SUMMIT, TRUMBULL, TUSCARAWAS, VAN WERT, WARREN, WAYNE, WILLIAMS

Special Jurisdictional Note : (A) Highway Construction, Sewer, Waterworks And Utility Construction, Industrial & Building Site, Heavy Construction, Airport Construction Or Railroad Construction Work.

Details :

Prevailing Wage Rate Skilled Crafts

Name of Union: Cement Mason Statewide Hwy Exhibit B District II

Change # : OCN01-2021fbCementHwy

Craft : Cement Mason Effective Date : 05/01/2021 Last Posted : 04/23/2021

	BHR		Fringe Benefit Payments						Irrevocable Fund		Total PWR	Overtime Rate
			H&W	Pension	App Tr.	Vac.	Annuity	Other	LECET (*)	MISC (*)		
Classification												
Cement Mason	\$32.02		\$8.25	\$7.35	\$0.65	\$0.00	\$2.25	\$0.07	\$0.00	\$0.00	\$50.59	\$66.60
Apprentice	Percent											
1st Year	70.00	\$22.41	\$8.25	\$7.35	\$0.65	\$0.00	\$2.25	\$0.07	\$0.00	\$0.00	\$40.98	\$52.19
2nd Year	80.00	\$25.62	\$8.25	\$7.35	\$0.65	\$0.00	\$2.25	\$0.07	\$0.00	\$0.00	\$44.19	\$56.99
3rd Year	90.00	\$28.82	\$8.25	\$7.35	\$0.65	\$0.00	\$2.25	\$0.07	\$0.00	\$0.00	\$47.39	\$61.80

Special Calculation Note : Other \$0.07 is for International Training Fund.

<p>Ratio :</p> <p>1 Journeymen to 1 Apprentice 2 to 1 thereafter</p>	<p>Jurisdiction (* denotes special jurisdictional note) :</p> <p>ALLEN, AUGLAIZE, BROWN, BUTLER, CARROLL, CLERMONT, COLUMBIANA, DEFIANCE, ERIE, HAMILTON, HARDIN, HIGHLAND, HOLMES, HURON, LOGAN, LORAIN, MAHONING, MEDINA, MERCER, OTTAWA, PAULDING, PORTAGE, SANDUSKY, SENECA, STARK, SUMMIT, TRUMBULL, TUSCARAWAS, VAN WERT, WARREN, WAYNE, WILLIAMS</p>
---	--

Special Jurisdictional Note : (B) Power Plant, Tunnels, Amusement Park, Athletic Stadium Site Work, Pollution Control, Sewer Plant, Waste Plant, & Water Treatment Facilities, Construction.

Details :

Prevailing Wage Rate Skilled Crafts

Name of Union: Electrical Local 71 High Tension Pipe Type Cable

Change # : LCN01-2024ibLoc71HighTension

Craft : Lineman Effective Date : 02/07/2024 Last Posted : 02/07/2024

	BHR		Fringe Benefit Payments					Irrevocable Fund		Total PWR	Overtime Rate	
			H&W	Pension	App Tr.	Vac.	Annuity	Other	LECET (*)			MISC (*)
Classification												
Electrical Lineman	\$50.66		\$7.25	\$1.52	\$0.51	\$0.00	\$12.16	\$0.75	\$0.00	\$0.00	\$72.85	\$98.18
Certified Lineman Welder	\$50.66		\$7.25	\$1.52	\$0.51	\$0.00	\$12.16	\$0.75	\$0.00	\$0.00	\$72.85	\$98.18
Certified Cable Splicer	\$50.66		\$7.25	\$1.52	\$0.51	\$0.00	\$12.16	\$0.75	\$0.00	\$0.00	\$72.85	\$98.18
Operator A	\$45.39		\$7.25	\$1.36	\$0.45	\$0.00	\$10.89	\$0.75	\$0.00	\$0.00	\$66.09	\$88.79
Operator B	\$40.18		\$7.25	\$1.21	\$0.40	\$0.00	\$9.64	\$0.75	\$0.00	\$0.00	\$59.43	\$79.52
Operator C	\$32.29		\$7.25	\$0.97	\$0.32	\$0.00	\$7.75	\$0.75	\$0.00	\$0.00	\$49.33	\$65.47
Groundman 0-12 months Exp	\$25.33		\$7.25	\$0.76	\$0.25	\$0.00	\$6.08	\$0.75	\$0.00	\$0.00	\$40.42	\$53.08
Groundman 0-12 months Exp w/CDL	\$27.86		\$7.25	\$0.84	\$0.28	\$0.00	\$6.69	\$0.75	\$0.00	\$0.00	\$43.67	\$57.60
Groundman 1 yr or more	\$27.86		\$7.25	\$0.84	\$0.28	\$0.00	\$6.69	\$0.75	\$0.00	\$0.00	\$43.67	\$57.60
Groundman 1 yr or more w/CDL	\$32.92		\$7.25	\$0.99	\$0.33	\$0.00	\$7.90	\$0.75	\$0.00	\$0.00	\$50.14	\$66.60
Equipment Mechanic A	\$40.18		\$7.25	\$1.21	\$0.40	\$0.00	\$9.64	\$0.75	\$0.00	\$0.00	\$59.43	\$79.52
Equipment Mechanic B	\$36.23		\$7.25	\$1.09	\$0.36	\$0.00	\$8.70	\$0.75	\$0.00	\$0.00	\$54.38	\$72.50
Equipment Mechanic C	\$32.29		\$7.25	\$0.97	\$0.32	\$0.00	\$7.75	\$0.75	\$0.00	\$0.00	\$49.33	\$65.47
X-Ray Technician	\$50.66		\$7.25	\$1.52	\$0.51	\$0.00	\$12.16	\$0.75	\$0.00	\$0.00	\$72.85	\$98.18
Apprentice	Percent											
1st 1000 hrs	60.00	\$30.40	\$7.25	\$0.91	\$0.30	\$0.00	\$7.30	\$0.75	\$0.00	\$0.00	\$46.91	\$62.10
2nd 1000 hrs	65.00	\$32.93	\$7.25	\$0.99	\$0.33	\$0.00	\$7.90	\$0.75	\$0.00	\$0.00	\$50.15	\$66.61
3rd 1000 hrs	70.00	\$35.46	\$7.25	\$1.06	\$0.35	\$0.00	\$8.51	\$0.75	\$0.00	\$0.00	\$53.38	\$71.11
4th 1000 hrs	75.00	\$38.00	\$7.25	\$1.14	\$0.38	\$0.00	\$9.12	\$0.75	\$0.00	\$0.00	\$56.64	\$75.63

5th 1000 hrs	80.00	\$40.53	\$7.25	\$1.22	\$0.41	\$0.00	\$9.73	\$0.75	\$0.00	\$0.00	\$59.89	\$80.15
6th 1000 hrs	85.00	\$43.06	\$7.25	\$1.29	\$0.43	\$0.00	\$10.33	\$0.75	\$0.00	\$0.00	\$63.11	\$84.64
7th 1000 hrs	90.00	\$45.59	\$7.25	\$1.37	\$0.46	\$0.00	\$10.94	\$0.75	\$0.00	\$0.00	\$66.36	\$89.16

Special Calculation Note : Other is Health Reimbursement Account

Operator "A"

John Henry Rock Drill, D-6 (or equivalent) and above, Trackhoe Digger, (320 Track excavator), Cranes (greater than 25 tons and less than 45 tons).

Operator "B"

Cranes (greater than 6 tons and up to 25 tons), Backhoes, Road Tractor, Dozer up to D-5, Pressure Digger- wheeled or tracked, all Tension wire Stringing equipment.

Operator "C"

Trench, Backhoe, Riding type vibratory Compactor, Ground Rod Driver, Boom Truck (6 ton & below), Skid Steer Loaders, Material Handler.

*All Operators of cranes 45 ton or larger shall be paid the journeyman rate of pay.

Ratio :

1 Journeyman to 1 Apprentice

Jurisdiction (* denotes special jurisdictional note) :

ADAMS, ASHLAND, ASHTABULA, ATHENS, AUGLAIZE, BELMONT, BROWN, BUTLER, CARROLL, CHAMPAIGN, CLARK, CLERMONT, CLINTON, COLUMBIANA, COSHOCTON, CRAWFORD, CUYAHOGA, DARKE, DELAWARE, FAIRFIELD, FAYETTE, FRANKLIN, GALLIA, GEAUGA, GREENE, GUERNSEY, HAMILTON, HARRISON, HIGHLAND, HOCKING, HOLMES, JACKSON, JEFFERSON, KNOX, LAKE, LAWRENCE, LICKING, LOGAN, LORAIN, MADISON, MAHONING, MARION, MEDINA, MEIGS, MERCER, MIAMI, MONROE, MONTGOMERY, MORGAN, MORROW, MUSKINGUM, NOBLE, PERRY, PICKAWAY, PIKE, PORTAGE, PREBLE, RICHLAND, ROSS, SCIOTO, SHELBY, STARK, SUMMIT, TRUMBULL, TUSCARAWAS, UNION, VINTON, WARREN, WASHINGTON, WAYNE

Special Jurisdictional Note :

Details :

Heli - Arc Welding will be paid \$.30 above Journeyman rate. Additional compensation of 10% over the Journeyman Lineman and Journeyman Technician for performing work on structures outside of buildings such as water towers, smoke stacks, radio and television towers, more than 75' above the ground.

Prevailing Wage Rate Skilled Crafts

Name of Union: Electrical Local 71 Outside Utility Power

Change # : LCN01-2024lbLoc7OutsideUtility

Craft : Lineman Effective Date : 02/07/2024 Last Posted : 02/07/2024

	BHR		Fringe Benefit Payments					Irrevocable Fund		Total PWR	Overtime Rate	
			H&W	Pension	App Tr.	Vac.	Annuity	Other	LECET (*)			MISC (*)
Classification												
Electrical Lineman	\$47.99		\$7.25	\$1.44	\$0.48	\$0.00	\$11.52	\$0.75	\$0.00	\$0.00	\$69.43	\$93.42
Substation Technician	\$47.99		\$7.25	\$1.44	\$0.48	\$0.00	\$11.52	\$0.75	\$0.00	\$0.00	\$69.43	\$93.42
Cable Splicer	\$50.26		\$7.25	\$1.51	\$0.50	\$0.00	\$12.06	\$0.75	\$0.00	\$0.00	\$72.33	\$97.46
Operator A	\$43.01		\$7.25	\$1.29	\$0.43	\$0.00	\$10.32	\$0.75	\$0.00	\$0.00	\$63.05	\$84.56
Operator B	\$38.02		\$7.25	\$1.14	\$0.38	\$0.00	\$9.12	\$0.75	\$0.00	\$0.00	\$56.66	\$75.67
Operator C	\$30.52		\$7.25	\$0.92	\$0.31	\$0.00	\$7.32	\$0.75	\$0.00	\$0.00	\$47.07	\$62.33
Groundman 0-12 months Exp	\$24.00		\$7.25	\$0.72	\$0.24	\$0.00	\$5.76	\$0.75	\$0.00	\$0.00	\$38.72	\$50.72
Groundman 0-12 months Exp w/CDL	\$26.40		\$7.25	\$0.79	\$0.26	\$0.00	\$6.33	\$0.75	\$0.00	\$0.00	\$41.78	\$54.98
Groundman 1 yr or more	\$26.40		\$7.25	\$0.79	\$0.26	\$0.00	\$6.33	\$0.75	\$0.00	\$0.00	\$41.78	\$54.98
Groundman 1 yr or more w/CDL	\$31.19		\$7.25	\$0.94	\$0.31	\$0.00	\$7.49	\$0.75	\$0.00	\$0.00	\$47.93	\$63.53
Equipment Mechanic A	\$38.02		\$7.25	\$1.14	\$0.38	\$0.00	\$9.12	\$0.75	\$0.00	\$0.00	\$56.66	\$75.67
Equipment Mechanic B	\$34.28		\$7.25	\$1.03	\$0.34	\$0.00	\$8.23	\$0.75	\$0.00	\$0.00	\$51.88	\$69.02
Equipment Mechanic C	\$30.52		\$7.25	\$0.92	\$0.31	\$0.00	\$7.32	\$0.75	\$0.00	\$0.00	\$47.07	\$62.33
Line Truck w/uuger	\$33.65		\$7.25	\$1.01	\$0.34	\$0.00	\$8.08	\$0.75	\$0.00	\$0.00	\$51.08	\$67.90
Apprentice	Percent											
1st 1000 hrs	60.00	\$28.79	\$7.25	\$0.86	\$0.29	\$0.00	\$6.91	\$0.75	\$0.00	\$0.00	\$44.85	\$59.25
2nd 1000 hrs	65.00	\$31.19	\$7.25	\$0.94	\$0.31	\$0.00	\$7.49	\$0.75	\$0.00	\$0.00	\$47.93	\$63.53
3rd 1000 hrs	70.00	\$33.59	\$7.25	\$1.01	\$0.34	\$0.00	\$8.06	\$0.75	\$0.00	\$0.00	\$51.00	\$67.80
4th 1000 hrs	75.00	\$35.99	\$7.25	\$1.08	\$0.36	\$0.00	\$8.64	\$0.75	\$0.00	\$0.00	\$54.07	\$72.07
5th 1000 hrs	80.00	\$38.39	\$7.25	\$1.15	\$0.38	\$0.00	\$9.21	\$0.75	\$0.00	\$0.00	\$57.13	\$76.33

6th 1000 hrs	85.00	\$40.79	\$7.25	\$1.22	\$0.41	\$0.00	\$9.79	\$0.75	\$0.00	\$0.00	\$60.21	\$80.61
7th 1000 hrs	90.00	\$43.19	\$7.25	\$1.30	\$0.43	\$0.00	\$10.37	\$0.75	\$0.00	\$0.00	\$63.29	\$84.89

Special Calculation Note : Other is Health Reimbursement Account

Operator "A"

John Henry Rock Drill, D-6 (or equivalent) and above, Trackhoe Digger, (320 Track excavator), Cranes (greater then 25 tons and less than 45 tons).

Operator "B"

Cranes (greater than 6 tons and up to 25 tons), Backhoes, Road Tractor, Dozer up to D-5, Pressure Digger- wheeled or tracked, all Tension wire Stringing equipment.

Operator "C"

Trench, Backhoe, Riding type vibratory Compactor, Ground Rod Driver, Boom Truck (6 ton & below), Skid Steer Loaders, Material Handler.

Ratio :

(1) Journeyman Lineman to (1) Apprentice

Jurisdiction (* denotes special jurisdictional note) :

ADAMS, ASHLAND, ASHTABULA, ATHENS, AUGLAIZE, BELMONT, BROWN, BUTLER, CARROLL, CHAMPAIGN, CLARK, CLERMONT, CLINTON, COLUMBIANA, COSHOCTON, CRAWFORD, CUYAHOGA, DARKE, DELAWARE, FAIRFIELD, FAYETTE, FRANKLIN, GALLIA, GEAUGA, GREENE, GUERNSEY, HAMILTON, HARRISON, HIGHLAND, HOCKING, HOLMES, JACKSON, JEFFERSON, KNOX, LAKE, LAWRENCE, LICKING, LOGAN, LORAIN, MADISON, MAHONING, MARION, MEDINA, MEIGS, MERCER, MIAMI, MONROE, MONTGOMERY, MORGAN, MORROW, MUSKINGUM, NOBLE, PERRY, PICKAWAY, PIKE, PORTAGE, PREBLE, RICHLAND, ROSS, SCIOTO, SHELBY, STARK, SUMMIT, TRUMBULL, TUSCARAWAS, UNION, VINTON, WARREN, WASHINGTON, WAYNE

Special Jurisdictional Note :

Details :

Heli - Arc Welding will be paid \$.30 above Journeyman rate. Additional compensation of 10% over the Journeyman Lineman and Journeyman Technician for performing work on structures outside of buildings such as water towers, smoke stacks, radio and television towers, more than 75' above the ground.

Prevailing Wage Rate Skilled Crafts

Name of Union: Electrical Local 71 Outside Utility Power

Change # : LCN01-2024lbLoc7OutsideUtility

Craft : Lineman Effective Date : 02/07/2024 Last Posted : 02/07/2024

	BHR		Fringe Benefit Payments					Irrevocable Fund		Total PWR	Overtime Rate	
			H&W	Pension	App Tr.	Vac.	Annuity	Other	LECET (*)			MISC (*)
Classification												
Electrical Lineman	\$47.99		\$7.25	\$1.44	\$0.48	\$0.00	\$11.52	\$0.75	\$0.00	\$0.00	\$69.43	\$93.42
Substation Technician	\$47.99		\$7.25	\$1.44	\$0.48	\$0.00	\$11.52	\$0.75	\$0.00	\$0.00	\$69.43	\$93.42
Cable Splicer	\$50.26		\$7.25	\$1.51	\$0.50	\$0.00	\$12.06	\$0.75	\$0.00	\$0.00	\$72.33	\$97.46
Operator A	\$43.01		\$7.25	\$1.29	\$0.43	\$0.00	\$10.32	\$0.75	\$0.00	\$0.00	\$63.05	\$84.56
Operator B	\$38.02		\$7.25	\$1.14	\$0.38	\$0.00	\$9.12	\$0.75	\$0.00	\$0.00	\$56.66	\$75.67
Operator C	\$30.52		\$7.25	\$0.92	\$0.31	\$0.00	\$7.32	\$0.75	\$0.00	\$0.00	\$47.07	\$62.33
Groundman 0-12 months Exp	\$24.00		\$7.25	\$0.72	\$0.24	\$0.00	\$5.76	\$0.75	\$0.00	\$0.00	\$38.72	\$50.72
Groundman 0-12 months Exp w/CDL	\$26.40		\$7.25	\$0.79	\$0.26	\$0.00	\$6.33	\$0.75	\$0.00	\$0.00	\$41.78	\$54.98
Groundman 1 yr or more	\$26.40		\$7.25	\$0.79	\$0.26	\$0.00	\$6.33	\$0.75	\$0.00	\$0.00	\$41.78	\$54.98
Groundman 1 yr or more w/CDL	\$31.19		\$7.25	\$0.94	\$0.31	\$0.00	\$7.49	\$0.75	\$0.00	\$0.00	\$47.93	\$63.53
Equipment Mechanic A	\$38.02		\$7.25	\$1.14	\$0.38	\$0.00	\$9.12	\$0.75	\$0.00	\$0.00	\$56.66	\$75.67
Equipment Mechanic B	\$34.28		\$7.25	\$1.03	\$0.34	\$0.00	\$8.23	\$0.75	\$0.00	\$0.00	\$51.88	\$69.02
Equipment Mechanic C	\$30.52		\$7.25	\$0.92	\$0.31	\$0.00	\$7.32	\$0.75	\$0.00	\$0.00	\$47.07	\$62.33
Line Truck w/uuger	\$33.65		\$7.25	\$1.01	\$0.34	\$0.00	\$8.08	\$0.75	\$0.00	\$0.00	\$51.08	\$67.90
Apprentice	Percent											
1st 1000 hrs	60.00	\$28.79	\$7.25	\$0.86	\$0.29	\$0.00	\$6.91	\$0.75	\$0.00	\$0.00	\$44.85	\$59.25
2nd 1000 hrs	65.00	\$31.19	\$7.25	\$0.94	\$0.31	\$0.00	\$7.49	\$0.75	\$0.00	\$0.00	\$47.93	\$63.53
3rd 1000 hrs	70.00	\$33.59	\$7.25	\$1.01	\$0.34	\$0.00	\$8.06	\$0.75	\$0.00	\$0.00	\$51.00	\$67.80
4th 1000 hrs	75.00	\$35.99	\$7.25	\$1.08	\$0.36	\$0.00	\$8.64	\$0.75	\$0.00	\$0.00	\$54.07	\$72.07
5th 1000 hrs	80.00	\$38.39	\$7.25	\$1.15	\$0.38	\$0.00	\$9.21	\$0.75	\$0.00	\$0.00	\$57.13	\$76.33

6th 1000 hrs	85.00	\$40.79	\$7.25	\$1.22	\$0.41	\$0.00	\$9.79	\$0.75	\$0.00	\$0.00	\$60.21	\$80.61
7th 1000 hrs	90.00	\$43.19	\$7.25	\$1.30	\$0.43	\$0.00	\$10.37	\$0.75	\$0.00	\$0.00	\$63.29	\$84.89

Special Calculation Note : Other is Health Reimbursement Account

Operator "A"

John Henry Rock Drill, D-6 (or equivalent) and above, Trackhoe Digger, (320 Track excavator), Cranes (greater then 25 tons and less than 45 tons).

Operator "B"

Cranes (greater than 6 tons and up to 25 tons), Backhoes, Road Tractor, Dozer up to D-5, Pressure Digger- wheeled or tracked, all Tension wire Stringing equipment.

Operator "C"

Trench, Backhoe, Riding type vibratory Compactor, Ground Rod Driver, Boom Truck (6 ton & below), Skid Steer Loaders, Material Handler.

Ratio :

(1) Journeyman Lineman to (1) Apprentice

Jurisdiction (* denotes special jurisdictional note) :

ADAMS, ASHLAND, ASHTABULA, ATHENS, AUGLAIZE, BELMONT, BROWN, BUTLER, CARROLL, CHAMPAIGN, CLARK, CLERMONT, CLINTON, COLUMBIANA, COSHOCTON, CRAWFORD, CUYAHOGA, DARKE, DELAWARE, FAIRFIELD, FAYETTE, FRANKLIN, GALLIA, GEauga, GREENE, GUERNSEY, HAMILTON, HARRISON, HIGHLAND, HOCKING, HOLMES, JACKSON, JEFFERSON, KNOX, LAKE, LAWRENCE, LICKING, LOGAN, LORAIN, MADISON, MAHONING, MARION, MEDINA, MEIGS, MERCER, MIAMI, MONROE, MONTGOMERY, MORGAN, MORROW, MUSKINGUM, NOBLE, PERRY, PICKAWAY, PIKE, PORTAGE, PREBLE, RICHLAND, ROSS, SCIOTO, SHELBY, STARK, SUMMIT, TRUMBULL, TUSCARAWAS, UNION, VINTON, WARREN, WASHINGTON, WAYNE

Special Jurisdictional Note :

Details :

Heli - Arc Welding will be paid \$.30 above Journeyman rate. Additional compensation of 10% over the Journeyman Lineman and Journeyman Technician for performing work on structures outside of buildings such as water towers, smoke stacks, radio and television towers, more than 75' above the ground.

Apprentice	Percent											
1st 1000 hrs	60.00	\$27.62	\$7.00	\$0.83	\$0.28	\$0.00	\$6.63	\$0.75	\$0.00	\$0.00	\$43.11	\$56.92
2nd 1000 hrs	65.00	\$29.92	\$7.00	\$0.90	\$0.30	\$0.00	\$7.18	\$0.75	\$0.00	\$0.00	\$46.05	\$61.01
3rd 1000 hrs	70.00	\$32.22	\$7.00	\$0.97	\$0.32	\$0.00	\$7.73	\$0.75	\$0.00	\$0.00	\$48.99	\$65.10
4th 1000 hrs	75.00	\$34.52	\$7.00	\$1.04	\$0.35	\$0.00	\$8.28	\$0.75	\$0.00	\$0.00	\$51.94	\$69.20
5th 1000 hrs	80.00	\$36.82	\$7.00	\$1.10	\$0.37	\$0.00	\$8.84	\$0.75	\$0.00	\$0.00	\$54.88	\$73.30
6th 1000 hrs	85.00	\$39.13	\$7.00	\$1.17	\$0.39	\$0.00	\$9.39	\$0.75	\$0.00	\$0.00	\$57.83	\$77.39
7th 1000 hrs	90.00	\$41.43	\$7.00	\$1.24	\$0.41	\$0.00	\$9.94	\$0.75	\$0.00	\$0.00	\$60.77	\$81.48

Special Calculation Note : Other is Health Retirement Account

Operator "A"

John Henry Rock Drill, D-6 (or equivalent) and above, Trackhoe Digger, (320 Track excavator), Cranes (greater then 25 tons and less than 45 tons).

Operator "B"

Cranes (greater than 6 tons and up to 25 tons), Backhoes, Road Tractor, Dozer up to D-5, Pressure Digger- wheeled or tracked, all Tension wire Stringing equipment.

Operator "C"

Trench, Backhoe, Riding type vibratory Compactor, Ground Rod Driver, Boom Truck (6 ton & below), Skid Steer Loaders, Material Handler.

Ratio :

(1) Journeyman Lineman to (1) Apprentice

Jurisdiction (* denotes special jurisdictional note) :

ADAMS, ASHLAND, ASHTABULA, ATHENS, AUGLAIZE, BELMONT, BROWN, BUTLER, CARROLL, CHAMPAIGN, CLARK, CLERMONT, CLINTON, COLUMBIANA, COSHOCTON, CRAWFORD, CUYAHOGA, DARKE, DELAWARE, FAIRFIELD, FAYETTE, FRANKLIN, GALLIA, GEAUGA, GREENE, GUERNSEY, HAMILTON, HARRISON, HIGHLAND, HOCKING, HOLMES, JACKSON, JEFFERSON, KNOX, LAKE, LAWRENCE, LICKING, LOGAN, LORAIN, MADISON, MAHONING, MARION, MEDINA, MEIGS, MERCER, MIAMI, MONROE, MONTGOMERY, MORGAN, MORROW, MUSKINGUM, NOBLE, PERRY, PICKAWAY, PIKE, PORTAGE, PREBLE, RICHLAND, ROSS, SCIOTO, SHELBY, STARK, SUMMIT, TRUMBULL, TUSCARAWAS, UNION, VINTON, WARREN, WASHINGTON, WAYNE

Special Jurisdictional Note : 0.30 is for Health Retirement Account.

Details :

Heli - Arc Welding will be paid \$.30 above Journeyman rate. Additional compensation of 10% over the

Prevailing Wage Rate Skilled Crafts

Name of Union: Electrical Local 71 Voice Data Video Outside

Change # : LCN02-2024ibLoc71VDV

Craft : Voice Data Video Effective Date : 03/06/2024 Last Posted : 03/06/2024

	BHR		Fringe Benefit Payments					Irrevocable Fund		Total PWR	Overtime Rate	
			H&W	Pension	App Tr.	Vac.	Annuity	Other	LECET (*)			MISC (*)
Classification												
Electrical Installer Technician I	\$35.39		\$7.25	\$1.06	\$0.00	\$0.00	\$1.77	\$0.00	\$0.00	\$0.00	\$45.47	\$63.17
Installer Technician II	\$33.37		\$7.25	\$1.00	\$0.00	\$0.00	\$1.67	\$0.00	\$0.00	\$0.00	\$43.29	\$59.97
Installer Repairman	\$33.37		\$7.25	\$1.00	\$0.00	\$0.00	\$1.67	\$0.00	\$0.00	\$0.00	\$43.29	\$59.97
Equipment Operator II	\$24.98		\$7.25	\$0.75	\$0.00	\$0.00	\$1.25	\$0.00	\$0.00	\$0.00	\$34.23	\$46.72
Cable Splicer	\$35.39		\$7.25	\$1.06	\$0.00	\$0.00	\$1.77	\$0.00	\$0.00	\$0.00	\$45.47	\$63.17
Ground Driver W/CDL	\$16.69		\$7.25	\$0.50	\$0.00	\$0.00	\$0.83	\$0.00	\$0.00	\$0.00	\$25.27	\$33.62
Groundman	\$14.57		\$7.25	\$0.44	\$0.00	\$0.00	\$0.73	\$0.00	\$0.00	\$0.00	\$22.99	\$30.28
Trainees	Percent											
Trainee F	50.02	\$17.70	\$7.25	\$0.53	\$0.00	\$0.89	\$0.00	\$0.00	\$0.00	\$0.00	\$26.37	\$35.22
Trainee E	58.00	\$20.53	\$7.25	\$0.62	\$0.00	\$1.03	\$0.00	\$0.00	\$0.00	\$0.00	\$29.43	\$39.69
Trainee D	66.00	\$23.36	\$7.25	\$0.70	\$0.00	\$1.17	\$0.00	\$0.00	\$0.00	\$0.00	\$32.48	\$44.16
Trainee C	74.00	\$26.19	\$7.25	\$0.79	\$0.00	\$1.31	\$0.00	\$0.00	\$0.00	\$0.00	\$35.54	\$48.63
Trainee B	82.00	\$29.02	\$7.25	\$0.87	\$0.00	\$1.45	\$0.00	\$0.00	\$0.00	\$0.00	\$38.59	\$53.10
Trainee A	90.00	\$31.85	\$7.25	\$0.96	\$0.00	\$1.59	\$0.00	\$0.00	\$0.00	\$0.00	\$41.65	\$57.58

Special Calculation Note :

Ratio :

1 Trainee to 1 Journeyman

Jurisdiction (* denotes special jurisdictional note) :

ADAMS, ASHLAND, ASHTABULA, ATHENS, AUGLAIZE, BELMONT, BROWN, BUTLER, CARROLL, CHAMPAIGN, CLARK, CLERMONT, CLINTON, COLUMBIANA, COSHOCTON, CRAWFORD, CUYAHOGA, DARKE, DELAWARE, FAIRFIELD, FAYETTE, FRANKLIN, GALLIA, GEAUGA, GREENE, GUERNSEY, HAMILTON, HARRISON, HIGHLAND, HOCKING, HOLMES, JACKSON, JEFFERSON, KNOX, LAKE, LAWRENCE, LICKING, LOGAN, LORAIN, MADISON, MAHONING, MARION, MEDINA, MEIGS, MERCER, MIAMI, MONROE, MONTGOMERY, MORGAN, MORROW, MUSKINGUM, NOBLE, PERRY, PICKAWAY, PIKE, PORTAGE, PREBLE, RICHLAND, ROSS, SCIOTO, SHELBY, STARK, SUMMIT, TRUMBULL, TUSCARAWAS, UNION, VINTON, WARREN, WASHINGTON, WAYNE

Special Jurisdictional Note :

Details :

Cable Splicer: Inspect and test lines or cables, analyze results, and evaluate transmission characteristics. Cover conductors with insulation or

seal splices with moisture-proof covering. Install, splice, test, and repair cables using tools or mechanical equipment. This will include the splicing of fiber.

Installer Technician I: Must know all aspects of telephone and cable work. This is to include aerial, underground, and manhole work. Must know how to climb and run bucket. Must have all the tools required to perform these tasks. Must be able to be responsible for the safety of the crew at all times. Must also have CDL license and have at least 5 years experience.

Installer Repairman: Perform tasks of repairing, installing, and testing phone and CATV services.

Installer Technician II: Have at least three years of telephone and CATV experience. Must have the knowledge of underground, aerial, and manhole work. Must be able to climb and operate bucket. Must have CDL. Must have all tools needed to perform these tasks.

Equipment Operator II: Able to operate a digger derrick or bucket truck. Have at least 3 years of experience and must have a valid CDL license.

Groundman W/CDL: Must have a valid CDL license and be able to perform tasks such as: climbing poles, pulling down guys, making up material, and getting appropriate tools for the job. Must have at least 5 year's experience.

Groundman: Perform tasks such as: climbing poles, pulling down guys, making up material, and getting appropriate tools for the job. Experience 0-5 years.

Prevailing Wage Rate Skilled Crafts

Name of Union: Electrical Local 71 Underground Residential Distribution

Change # : LCN01-2024ibLoc7URD

Craft : Lineman Effective Date : 02/07/2024 Last Posted : 02/07/2024

	BHR		Fringe Benefit Payments						Irrevocable Fund		Total PWR	Overtime Rate
			H&W	Pension	App Tr.	Vac.	Annuity	Other	LECET (*)	MISC (*)		
Classification												
URD Electrician	\$36.41		\$7.25	\$1.09	\$0.36	\$0.00	\$8.74	\$0.75	\$0.00	\$0.00	\$54.60	\$72.80
Equipment Operator A	\$32.57		\$7.25	\$0.98	\$0.33	\$0.00	\$7.82	\$0.75	\$0.00	\$0.00	\$49.70	\$65.98
Equipment Operator B	\$29.91		\$7.25	\$0.90	\$0.30	\$0.00	\$7.18	\$0.75	\$0.00	\$0.00	\$46.29	\$61.25
Directional Drill Locator	\$32.57		\$7.25	\$0.98	\$0.33	\$0.00	\$7.82	\$0.75	\$0.00	\$0.00	\$49.70	\$65.98
Directional Drill Operator	\$29.91		\$7.25	\$0.90	\$0.30	\$0.00	\$7.18	\$0.75	\$0.00	\$0.00	\$46.29	\$61.25
Groundman 0-12 months Exp	\$23.64		\$7.25	\$0.71	\$0.24	\$0.00	\$5.76	\$0.75	\$0.00	\$0.00	\$38.35	\$50.17
Groundman 0-12 months Exp w/CDL	\$26.07		\$7.25	\$0.78	\$0.26	\$0.00	\$6.26	\$0.75	\$0.00	\$0.00	\$41.37	\$54.41
Groundman 1 yr or more	\$26.07		\$7.25	\$0.78	\$0.26	\$0.00	\$6.26	\$0.75	\$0.00	\$0.00	\$41.37	\$54.41
Groundman 1 yr or more w/CDL	\$30.96		\$7.25	\$0.93	\$0.31	\$0.00	\$7.43	\$0.75	\$0.00	\$0.00	\$47.63	\$63.11
Apprentice	Percent											
1st 1000 hrs	80.00	\$29.13	\$7.25	\$0.87	\$0.29	\$0.00	\$6.99	\$0.75	\$0.00	\$0.00	\$45.28	\$59.84
2nd 1000 hrs	85.00	\$30.95	\$7.25	\$0.93	\$0.31	\$0.00	\$7.43	\$0.75	\$0.00	\$0.00	\$47.62	\$63.09
3rd 1000 hrs	90.00	\$32.77	\$7.25	\$0.98	\$0.33	\$0.00	\$7.86	\$0.75	\$0.00	\$0.00	\$49.94	\$66.32
4th 1000 hrs	95.00	\$34.59	\$7.25	\$1.04	\$0.35	\$0.00	\$8.28	\$0.75	\$0.00	\$0.00	\$52.26	\$69.55

Special Calculation Note : Other: Health Reimbursement Account

Ratio :

(1) Journeyman Lineman to (1) Apprentice

Jurisdiction (* denotes special jurisdictional note) :

ADAMS, ASHLAND, ASHTABULA, ATHENS, AUGLAIZE, BELMONT, BROWN, BUTLER, CARROLL, CHAMPAIGN, CLARK, CLERMONT, CLINTON, COLUMBIANA, COSHOCTON, CRAWFORD, CUYAHOGA, DARKE, DELAWARE, FAIRFIELD, FAYETTE, FRANKLIN, GALLIA, GEAUGA, GREENE, GUERNSEY, HAMILTON, HARRISON, HIGHLAND, HOCKING, HOLMES, JACKSON, JEFFERSON, KNOX, LAKE, LAWRENCE, LICKING, LOGAN, LORAIN, MADISON, MAHONING,

MARION, MEDINA, MEIGS, MERCER, MIAMI, MONROE,
MONTGOMERY, MORGAN, MORROW, MUSKINGUM, NOBLE,
PERRY, PICKAWAY, PIKE, PORTAGE, PREBLE, RICHLAND,
ROSS, SCIOTO, SHELBY, STARK, SUMMIT, TRUMBULL,
TUSCARAWAS, UNION, VINTON, WARREN, WASHINGTON,
WAYNE

Special Jurisdictional Note :

Details :
This work applies to projects designated for any outside Underground Residential Distribution construction work for electrical utilities, municipalities and rural electrification projects.

Prevailing Wage Rate Skilled Crafts

Name of Union: Electrical Local 82 Inside

Change # : LCR01-2023ibLoc82in

Craft : Electrical Effective Date : 12/27/2023 Last Posted : 12/27/2023

	BHR		Fringe Benefit Payments					Irrevocable Fund		Total PWR	Overtime Rate	
			H&W	Pension	App Tr.	Vac.	Annuity	Other	LECET (*)			MISC (*)
Classification												
Electrician	\$36.00		\$7.55	\$9.83	\$0.61	\$0.00	\$4.00	\$0.00	\$0.00	\$0.00	\$57.99	\$75.99
Apprentice	Percent											
1st period 0 - 1000 hrs	42.00	\$15.12	\$4.14	\$0.65	\$0.26	\$0.00	\$0.00	\$0.00	\$0.00	\$0.00	\$20.17	\$27.73
2nd period 1001-2000 hrs	42.00	\$15.12	\$4.14	\$0.65	\$0.26	\$0.00	\$0.00	\$0.00	\$0.00	\$0.00	\$20.17	\$27.73
3rd period 2001-3500 hrs	47.00	\$16.92	\$7.02	\$4.62	\$0.29	\$0.00	\$1.88	\$0.00	\$0.00	\$0.00	\$30.73	\$39.19
4th period 3501-5000 hrs	52.00	\$18.72	\$7.07	\$5.11	\$0.32	\$0.00	\$2.08	\$0.00	\$0.00	\$0.00	\$33.30	\$42.66
5th period 5001-6500 hrs	62.00	\$22.32	\$7.17	\$6.10	\$0.38	\$0.00	\$2.48	\$0.00	\$0.00	\$0.00	\$38.45	\$49.61
6th period 6501-8000 hrs	77.00	\$27.72	\$7.32	\$7.57	\$0.47	\$0.00	\$3.08	\$0.00	\$0.00	\$0.00	\$46.16	\$60.02

Special Calculation Note : No special calculations for this skilled craft wage rate are required at this time.

Ratio :

1 to 3 Journeymen to 4 Apprentices
4 to 6 Journeymen to 8 Apprentices
per job site

Jurisdiction (* denotes special jurisdictional note) :

CLINTON, DARKE, GREENE, MIAMI,
MONTGOMERY, PREBLE, WARREN*

Special Jurisdictional Note : The following townships in Warren County are included: Clearcreek, Franklin and Wayne.

Details :

Prevailing Wage Rate Skilled Crafts

Name of Union: Electrical Local 82 Inside Lt Commercial South West

Change # : LCNO1-2021sksLoc82in

Craft : Electrical Effective Date : 03/30/2022 Last Posted : 03/30/2022

	BHR		Fringe Benefit Payments					Irrevocable Fund		Total PWR	Overtime Rate	
			H&W	Pension	App Tr.	Vac.	Annuity	Other	LECET (*)	MISC (*)		
Classification												
Electrician	\$33.25		\$6.47	\$9.35	\$0.72	\$0.00	\$3.50	\$0.00	\$0.00	\$0.00	\$53.29	\$69.91
CE-3 12,001- 14,000	\$24.66		\$6.47	\$0.74	\$0.72	\$0.00	\$0.74	\$0.00	\$0.00	\$0.10	\$33.43	\$45.76
CE-2 10,001- 12,000 Hrs	\$19.56		\$6.47	\$0.59	\$0.72	\$0.00	\$0.59	\$0.00	\$0.00	\$0.10	\$28.03	\$37.81
CE-1 8,001- 10,000 Hrs	\$17.86		\$6.47	\$0.54	\$0.72	\$0.00	\$0.54	\$0.00	\$0.00	\$0.10	\$26.23	\$35.16
CW-4 6,001- 8,000 Hrs	\$16.16		\$6.47	\$0.48	\$0.72	\$0.00	\$0.48	\$0.00	\$0.00	\$0.10	\$24.41	\$32.49
CW-3 4,001- 6,000 Hrs	\$14.46		\$6.47	\$0.43	\$0.72	\$0.00	\$0.43	\$0.00	\$0.00	\$0.10	\$22.61	\$29.84
CW-2 2,001- 4,000 Hrs	\$13.61		\$6.47	\$0.41	\$0.72	\$0.00	\$0.41	\$0.00	\$0.00	\$0.10	\$21.72	\$28.52
CW-1 0- 2,000 Hrs	\$12.76		\$6.47	\$0.38	\$0.72	\$0.00	\$0.38	\$0.00	\$0.00	\$0.10	\$20.81	\$27.19
Apprentice	Percent											
1st period 0 - 1000 hrs	42.00	\$13.97	\$4.07	\$0.62	\$0.24	\$0.00	\$0.00	\$0.00	\$0.00	\$0.00	\$18.89	\$25.88
2nd period 1001-2000 hrs	42.00	\$13.97	\$4.07	\$0.62	\$0.24	\$0.00	\$0.00	\$0.00	\$0.00	\$0.00	\$18.89	\$25.88
3rd period 2001-3500 hrs	47.00	\$15.63	\$6.92	\$4.39	\$0.27	\$0.00	\$1.65	\$0.00	\$0.00	\$0.00	\$28.86	\$36.67
4th period 3501-5000 hrs	52.00	\$17.29	\$6.97	\$4.86	\$0.29	\$0.00	\$1.82	\$0.00	\$0.00	\$0.00	\$31.23	\$39.88
5th period 5001-6500	62.00	\$20.61	\$7.07	\$5.80	\$0.35	\$0.00	\$2.17	\$0.00	\$0.00	\$0.00	\$36.01	\$46.31

hrs												
6th period 6501-8000 hrs	77.00	\$25.60	\$7.22	\$7.20	\$0.44	\$0.00	\$2.70	\$0.00	\$0.00	\$0.00	\$43.16	\$55.96

Special Calculation Note : *Misc amount is Administrative Fees

Ratio :

1 to 3 Journeymen to 3 Apprentices
 4 to 6 Journeymen to 6 Apprentices
 per job site

Jurisdiction (* denotes special jurisdictional note) :

CLINTON, DARKE, GREENE, MIAMI,
 MONTGOMERY, PREBLE, WARREN*

Construction Electrician and Construction Wireman Ratio

There shall be a minimum ratio of one inside Journeyman to every (4) employees of different classification per jobsite. An inside Journeyman Wireman is required on the project as the fifth (5th) worker or when apprentices are used.

Special Jurisdictional Note : The following townships in Warren County are included: Clearcreek, Franklin and Wayne.

The scope of work for the light commercial agreement shall apply to the following facilities not to exceed 200,000 square feet; office buildings, shopping centers, auto sales agencies and garages, churches, funeral homes, nursing homes, hotels, retail and wholesale facilities, small stand-alone manufacturing facilities when free standing and not part of a larger facility (not to exceed 50,000 square fee), solar projects (500 panels or less) unless otherwise covered under the agreement, lighting retrofits (when not associated with remodels involving branch re-circuiting) lighting retrofits shall be defined as the changing of lamps and ballasts in existing light fixtures and shall also include the one for one replacement of existing fixtures, warehouses, gas stations, food service centers, restaurants, entertainment facilities, hospitals, clinics, motels, residential buildings.

Details :

Prevailing Wage Rate Skilled Crafts

Name of Union: Electrical Local 82 Lightning Rod

Change # : LCN02-2022ibLoc82

Craft : Electrical Effective Date : 12/05/2022 Last Posted : 11/23/2022

	BHR	Fringe Benefit Payments						Irrevocable Fund		Total PWR	Overtime Rate
		H&W	Pension	App Tr.	Vac.	Annuity	Other	LECET (*)	MISC (*)		
Classification											
Electrical Lightning Rod Technican	\$32.79	\$7.45	\$9.58	\$0.00	\$0.00	\$3.50	\$0.00	\$0.00	\$0.00	\$53.32	\$69.71

Special Calculation Note : No Apprentice approved by OSAC.

Ratio :

Jurisdiction (* denotes special jurisdictional note) :

CLINTON, DARKE, GREENE, MIAMI,
MONTGOMERY, PREBLE, WARREN*

Special Jurisdictional Note : The following townships in Warren County are included: (Clearcreek, Franklin and Wayne)

Details :

Prevailing Wage Rate Skilled Crafts

Name of Union: Electrical Local 82 Voice Data Video

Change # : LCN01-2023ibLoc82VDV

Craft : Voice Data Video Effective Date : 11/27/2023 Last Posted : 11/22/2023

	BHR		Fringe Benefit Payments					Irrevocable Fund		Total PWR	Overtime Rate	
			H&W	Pension	App Tr.	Vac.	Annuity	Other	LECET (*)			MISC (*)
Classification												
Electrical Installer Technician A	\$27.70		\$6.70	\$6.83	\$0.53	\$0.00	\$0.00	\$0.00	\$0.00	\$0.00	\$41.76	\$55.61
Electrical Installer Technician B	\$26.32		\$6.70	\$6.79	\$0.50	\$0.00	\$0.00	\$0.00	\$0.00	\$0.00	\$40.31	\$53.47
JW Installer Technician	\$24.93		\$6.70	\$6.75	\$0.47	\$0.00	\$0.00	\$0.00	\$0.00	\$0.00	\$38.85	\$51.32
NON BICSI Installer	\$18.01		\$3.94	\$0.54	\$0.34	\$0.00	\$0.00	\$0.00	\$0.00	\$0.00	\$22.83	\$31.83
Apprentice	Percent											
1st 0-1000 hours	55.00	\$15.24	\$3.94	\$3.76	\$0.29	\$0.00	\$0.00	\$0.00	\$0.00	\$0.00	\$23.23	\$30.84
2nd 1001-2000 hours	55.00	\$15.24	\$3.94	\$3.76	\$0.29	\$0.00	\$0.00	\$0.00	\$0.00	\$0.00	\$23.23	\$30.84
3rd 2001-3000 hours	65.00	\$18.00	\$6.65	\$4.44	\$0.34	\$0.00	\$0.00	\$0.00	\$0.00	\$0.00	\$29.44	\$38.44
4th 3001-4000 hours	65.00	\$18.00	\$6.65	\$4.44	\$0.34	\$0.00	\$0.00	\$0.00	\$0.00	\$0.00	\$29.44	\$38.44
5th 4001-5000 hours	75.00	\$20.77	\$6.66	\$6.62	\$0.39	\$0.00	\$0.00	\$0.00	\$0.00	\$0.00	\$34.45	\$44.83
6th 5001-6000 hours	75.00	\$20.77	\$6.66	\$6.62	\$0.39	\$0.00	\$0.00	\$0.00	\$0.00	\$0.00	\$34.45	\$44.83
7th 6001-7000 hours	80.00	\$22.16	\$6.67	\$6.66	\$0.42	\$0.00	\$0.00	\$0.00	\$0.00	\$0.00	\$35.91	\$46.99
8th 7001 hours	80.00	\$22.16	\$6.67	\$6.66	\$0.42	\$0.00	\$0.00	\$0.00	\$0.00	\$0.00	\$35.91	\$46.99
Cable Puller	50.00	\$13.85	\$3.94	\$0.42	\$0.26	\$0.00	\$0.25	\$0.00	\$0.00	\$0.00	\$18.72	\$25.65

Special Calculation Note : No special calculations for this skilled craft wage rate are required at this time.

Ratio :

1 Journeymen to 2 Apprentice

Jurisdiction (* denotes special jurisdictional note) :

CLINTON, DARKE, GREENE, MIAMI,
MONTGOMERY, PREBLE, WARREN*

Special Jurisdictional Note : The following townships in Warren County are included: (Clearcreek, Franklin and Wayne)

Details :

Work covered but not limited to: installation which utilize transmission and/or transference of voice, sound, vision or digital for commercial, education, security and entertainment purposes for the following:

TV monitoring and surveillance, background-foreground music, intercom and telephone interconnect, inventory control systems, microwave transmission, multimedia, multiplex, nurse call system, radio page, school intercom, sound and low voltage master clock systems.

Fire Alarm work is excluded on all new construction sites or wherever the fire alarm system is installed in conduit.

All HVAC control work is not covered by this wage rate but by the Inside Electrical wage rate.

Prevailing Wage Rate Skilled Crafts

Name of Union: Electrical Local 648 Voice Data Video

Change # : LCN01-2023ibLoc648VDV

Craft : Voice Data Video Effective Date : 11/27/2023 Last Posted : 11/22/2023

	BHR		Fringe Benefit Payments					Irrevocable Fund		Total PWR	Overtime Rate	
			H&W	Pension	App Tr.	Vac.	Annuity	Other	LECET (*)			MISC (*)
Classification												
Electrical Installer Technician A	\$29.30		\$6.70	\$0.88	\$0.56	\$0.00	\$4.40	\$0.00	\$0.00	\$0.00	\$41.84	\$56.49
Electrical Installer Technician B	\$27.84		\$6.70	\$0.84	\$0.53	\$0.00	\$4.40	\$0.00	\$0.00	\$0.00	\$40.31	\$54.23
JW Installer Technician B	\$26.37		\$6.70	\$0.79	\$0.50	\$0.00	\$4.40	\$0.00	\$0.00	\$0.00	\$38.76	\$51.95
Non BICSI Installer	\$19.05		\$3.94	\$0.57	\$0.36	\$0.00	\$2.00	\$0.00	\$0.00	\$0.00	\$25.92	\$35.45
Apprentice												
	Percent											
1st period 0-800 hrs	55.00	\$16.12	\$3.94	\$0.48	\$0.31	\$0.00	\$2.42	\$0.00	\$0.00	\$0.00	\$23.26	\$31.32
2nd period 801-1600 hrs	55.00	\$16.12	\$3.94	\$0.48	\$0.31	\$0.00	\$2.42	\$0.00	\$0.00	\$0.00	\$23.26	\$31.32
3rd period 1601-2400 hrs	65.00	\$19.05	\$6.65	\$0.57	\$0.36	\$0.00	\$2.86	\$0.00	\$0.00	\$0.00	\$29.48	\$39.01
4th period 2401-3200 hrs	65.00	\$19.05	\$6.65	\$0.57	\$0.36	\$0.00	\$2.86	\$0.00	\$0.00	\$0.00	\$29.48	\$39.01
5th period 3201-4000 hrs	75.00	\$21.98	\$6.66	\$0.66	\$0.42	\$0.00	\$4.40	\$0.00	\$0.00	\$0.00	\$34.12	\$45.10
6th period 4001-4800 hrs	75.00	\$21.98	\$6.66	\$0.66	\$0.42	\$0.00	\$4.40	\$0.00	\$0.00	\$0.00	\$34.12	\$45.10
7th period 4801-4900hr	80.00	\$23.44	\$6.67	\$0.70	\$0.45	\$0.00	\$4.40	\$0.00	\$0.00	\$0.00	\$35.66	\$47.38

8th period 4901- 5000hrs	80.00	\$23.44	\$6.67	\$0.70	\$0.45	\$0.00	\$4.40	\$0.00	\$0.00	\$0.00	\$35.66	\$47.38
Cable Puller	50.00	\$14.65	\$3.94	\$0.44	\$0.25	\$0.00	\$0.25	\$0.00	\$0.00	\$0.00	\$19.53	\$26.86

Special Calculation Note :

Ratio :

1 Technician to 2 Apprentice

Jurisdiction (* denotes special jurisdictional note) :

BUTLER, WARREN*

Special Jurisdictional Note : The following townships In Warren County are included: (Deerfield, Hamilton, Harlan, Massie, Salem, Turtle Creek, Union, and Washington)

Details :

The following work is excluded from the Teledata Technician work scope:

*The installation of computer systems in industrial applications such as assembly lines, robotics, computer controller manufacturing systems.

*The installation of conduit and/or raceways shall be installed by Inside Wireman. On sites where there is no Inside Wireman employed, the

Teledata Technician may install raceway or conduit not greater than 10 ft.

*Fire Alarm work is excluded on all new construction sites or wherever the fire alarm system is installed in conduit

*All HVAC control work.

Prevailing Wage Rate Skilled Crafts

Name of Union: Electrical Local 648 Inside

Change # : LCN01-2023ibLoc648in

Craft : Electrical Effective Date : 09/13/2023 Last Posted : 09/13/2023

	BHR		Fringe Benefit Payments					Irrevocable Fund		Total PWR	Overtime Rate	
			H&W	Pension	App Tr.	Vac.	Annuity	Other	LECET (*)			MISC (*)
Classification												
Electrician	\$34.00		\$7.45	\$7.64	\$0.51	\$0.00	\$5.36	\$1.02	\$0.00	\$0.00	\$55.98	\$72.98
Apprentice		Percent										
1st period 0-1000 hrs	50.00	\$17.00	\$4.32	\$0.00	\$0.26	\$0.00	\$3.07	\$0.51	\$0.00	\$0.00	\$25.16	\$33.66
2nd period 1001-2000 hrs	50.00	\$17.00	\$4.32	\$0.00	\$0.26	\$0.00	\$3.07	\$0.51	\$0.00	\$0.00	\$25.16	\$33.66
3rd period 2001-3500 hrs	55.00	\$18.70	\$7.45	\$4.20	\$0.28	\$0.00	\$4.01	\$0.56	\$0.00	\$0.00	\$35.20	\$44.55
4th period 3501-5000 hrs	60.00	\$20.40	\$7.45	\$4.58	\$0.31	\$0.00	\$4.15	\$0.61	\$0.00	\$0.00	\$37.50	\$47.70
5th period 5001-6500 hrs	65.00	\$22.10	\$7.45	\$4.97	\$0.33	\$0.00	\$4.31	\$0.66	\$0.00	\$0.00	\$39.82	\$50.87
6th period 6501-8000 hrs	75.00	\$25.50	\$7.45	\$5.73	\$0.38	\$0.00	\$4.59	\$0.77	\$0.00	\$0.00	\$44.42	\$57.17

Special Calculation Note : Other is NEBF (Natioanl Electrical Benifit Fund.)

Ratio :

1-3 Journeyman to 2 Apprentices or fraction thereof:
 4-6 Journeymen to 4 Apprentice
 7-9 Journeymen to 6 Apprentice
 10-12 Journeymen to 8 Apprentice
 first person assigned to any job site shall be a journeyman

Jurisdiction (* denotes special jurisdictional note) :

BUTLER, WARREN*

Special Jurisdictional Note : In Warren County the following townships are included: (Deerfield, Hamilton, Harlan, Massie, Salem, Turtle Creek, Union, and Washington)

Details :

Electricians while splicing cable shall receive \$.50 an hour above the regular electrical rate.

All work that requires the use of gas masks or respirators, shall be paid 50% above the appropriate rate of pay. Work up to & including 40 feet shall be paid \$.50 over the journeyman rate. All work from a Boatswain Chair, Swinging Scaffold, or Barrel shall be at double the Journeyman rate. Workmen required to work 50 feet or more below the surface of the earth will be paid 50% above the Journeyman rate.

Prevailing Wage Rate Skilled Crafts

Name of Union: Electrical Local 648 Lt Commercial South West

Change # : LCN01-2024ibLoc648in

Craft : Electrical Effective Date : 01/10/2024 Last Posted : 01/10/2024

	BHR	Fringe Benefit Payments						Irrevocable Fund		Total PWR	Overtime Rate
		H&W	Pension	App Tr.	Vac.	Annuity	Other	LECET (*)	MISC (*)		
Classification											
Electrician	\$34.00	\$7.45	\$7.64	\$0.51	\$0.00	\$5.36	\$0.38	\$0.00	\$0.20	\$55.54	\$72.54
CE-3 12,001- 14,000 Hrs	\$27.05	\$6.67	\$0.81	\$0.88	\$0.00	\$0.81	\$0.00	\$0.00	\$0.00	\$36.22	\$49.75
CE-2 10,001- 12,000 Hrs	\$21.64	\$6.67	\$0.65	\$0.88	\$0.00	\$0.65	\$0.00	\$0.00	\$0.00	\$30.49	\$41.31
CE-1 8,001- 10,000 Hrs	\$19.83	\$6.67	\$0.59	\$0.88	\$0.00	\$0.59	\$0.00	\$0.00	\$0.00	\$28.56	\$38.48
CW-4 6,001- 8,000 Hrs	\$18.03	\$6.67	\$0.54	\$0.88	\$0.00	\$0.54	\$0.00	\$0.00	\$0.00	\$26.66	\$35.68
CW-3 4,001- 6,000 Hrs	\$16.23	\$6.67	\$0.49	\$0.88	\$0.00	\$0.49	\$0.00	\$0.00	\$0.00	\$24.76	\$32.88
CW-2 2,001- 4,000 Hrs	\$15.33	\$6.67	\$0.46	\$0.88	\$0.00	\$0.46	\$0.00	\$0.00	\$0.00	\$23.80	\$31.46
CW-1 0- 2,000 Hrs	\$14.42	\$6.67	\$0.43	\$0.88	\$0.00	\$0.43	\$0.00	\$0.00	\$0.00	\$22.83	\$30.04

Special Calculation Note : Other is for NEBF (National Electrical Benefit Fund)

Ratio :

Construction Electrician and Construction Wireman Ratio

There shall be a minimum ratio of one inside Journeyman to every (4) employees of different classification per jobsite. An inside Journeyman Wireman is required on the project as the fifth (5th) worker or when apprentices are used

Jurisdiction (* denotes special jurisdictional note) :

BUTLER, WARREN*

Special Jurisdictional Note : In Warren County the following townships are included: (Deerfield, Hamilton, Harlan, Massie, Salem, Turtle Creek, Union, and Washington)

The scope of work for the light commercial agreement shall apply to the following facilities not to exceed 200,000 square feet; office buildings, shopping centers, auto sales agencies and garages, churches, funeral homes, nursing homes, hotels, retail and wholesale facilities, small stand-alone manufacturing facilities when free standing and not part of a larger facility (not to exceed 50,000 square feet), solar projects (500 panels or less) unless otherwise covered under the agreement, lighting retrofits (when not associated with remodels involving branch re-circuiting) lighting retrofits shall be defined as the changing of lamps and ballasts in existing light fixtures and shall also include the one for one replacement of existing fixtures, warehouses, gas stations, food service centers, restaurants, entertainment facilities, hospitals, clinics, motels, residential buildings.

Details :

Electricians while splicing cable shall receive \$.50 an hour above the regular electrical rate.

All work that requires the use of gas masks or respirators, shall be paid 50% above the appropriate rate of pay. Work up to & including 40 feet shall be paid \$.50 over the journeyman rate. All work from a Boatswain Chair, Swinging Scaffold, or Barrel shall be at double the Journeyman rate. Workmen required to work 50 feet or more below the surface of the earth will be paid 50% above the Journeyman rate.

Prevailing Wage Rate Skilled Crafts

Name of Union: Electrical Local 648 Voice Data Video

Change # : LCR01-2021sksLoc648VDV

Craft : Voice Data Video Effective Date : 12/22/2021 Last Posted : 12/22/2021

	BHR		Fringe Benefit Payments					Irrevocable Fund		Total PWR	Overtime Rate	
			H&W	Pension	App Tr.	Vac.	Annuity	Other	LECET (*)			MISC (*)
Classification												
Electrical Installer Technician A	\$25.95		\$6.60	\$0.78	\$0.49	\$0.00	\$4.40	\$0.00	\$0.00	\$0.00	\$38.22	\$51.20
Electrical Installer Technician B	\$24.65		\$6.60	\$0.74	\$0.47	\$0.00	\$4.40	\$0.00	\$0.00	\$0.00	\$36.86	\$49.18
JW Installer Technician B	\$23.36		\$6.60	\$0.70	\$0.44	\$0.00	\$4.40	\$0.00	\$0.00	\$0.00	\$35.50	\$47.18
Non BICSI Installer	\$16.87		\$3.00	\$0.51	\$0.32	\$0.00	\$2.40	\$0.00	\$0.00	\$0.00	\$23.10	\$31.53
Apprentice												
	Percent											
1st period 0-800 hrs	55.00	\$14.27	\$3.00	\$0.43	\$0.27	\$0.00	\$0.25	\$0.00	\$0.00	\$0.00	\$18.22	\$25.36
2nd period 801-1600 hrs	55.00	\$14.27	\$3.00	\$0.43	\$0.27	\$0.00	\$0.25	\$0.00	\$0.00	\$0.00	\$18.22	\$25.36
3rd period 1601-2400 hrs	65.00	\$16.87	\$6.50	\$0.51	\$0.32	\$0.00	\$4.40	\$0.00	\$0.00	\$0.00	\$28.60	\$37.03
4th period 2401-3200 hrs	65.00	\$16.87	\$6.50	\$0.51	\$0.32	\$0.00	\$4.40	\$0.00	\$0.00	\$0.00	\$28.60	\$37.03
5th period 3201-4000 hrs	75.00	\$19.46	\$6.53	\$0.58	\$0.37	\$0.00	\$4.40	\$0.00	\$0.00	\$0.00	\$31.34	\$41.07
6th period 4001-4800 hrs	75.00	\$19.46	\$6.53	\$0.58	\$0.37	\$0.00	\$4.40	\$0.00	\$0.00	\$0.00	\$31.34	\$41.07
7th period 4801-4900hr	80.00	\$20.76	\$6.54	\$0.62	\$0.39	\$0.00	\$4.40	\$0.00	\$0.00	\$0.00	\$32.71	\$43.09

8th period 4901- 5000hrs	80.00	\$20.76	\$6.54	\$0.62	\$0.39	\$0.00	\$4.40	\$0.00	\$0.00	\$0.00	\$32.71	\$43.09
Cable Puller	50.00	\$12.98	\$3.00	\$0.39	\$0.25	\$0.00	\$0.25	\$0.00	\$0.00	\$0.00	\$16.86	\$23.35

Special Calculation Note :

Ratio :

1 Technician to 2 Apprentice

Jurisdiction (* denotes special jurisdictional note) :

BUTLER, WARREN*

Special Jurisdictional Note : The following townships In Warren County are included: (Deerfield, Hamilton, Harlan, Massie, Salem, Turtle Creek, Union, and Washington)

Details :

The following work is excluded from the Teledata Technician work scope:

*The installation of computer systems in industrial applications such as assembly lines, robotics, computer controller manufacturing systems.

*The installation of conduit and/or raceways shall be installed by Inside Wireman. On sites where there is no Inside Wireman employed, the Teledata Technician may install raceway or conduit not greater than 10 ft.

*Fire Alarm work is excluded on all new construction sites or wherever the fire alarm system is installed in conduit

*All HVAC control work.

Prevailing Wage Rate Skilled Crafts

Name of Union: Elevator Local 11

Change # : LCN01-2020fbLoc11

Craft : Elevator Effective Date : 01/05/2021 Last Posted : 01/05/2021

	BHR		Fringe Benefit Payments					Irrevocable Fund		Total PWR	Overtime Rate	
			H&W	Pension	App Tr.	Vac.	Annuity	Other	LECET (*)			MISC (*)
Classification												
Elevator Mechanic	\$48.82		\$15.88	\$10.46	\$0.64	\$3.91	\$8.85	\$1.56	\$0.00	\$0.00	\$90.12	\$114.53
Probationary Apprentice	50.00	\$24.41	\$0.00	\$0.00	\$0.00	\$1.46	\$0.00	\$0.78	\$0.00	\$0.00	\$26.65	\$38.86
1st year	55.00	\$26.85	\$15.88	\$10.46	\$0.64	\$1.61	\$8.85	\$0.86	\$0.00	\$0.00	\$65.15	\$78.58
2nd year	65.00	\$31.73	\$15.88	\$10.46	\$0.64	\$1.90	\$8.85	\$1.02	\$0.00	\$0.00	\$70.48	\$86.35
3rd year	70.00	\$34.17	\$15.88	\$10.46	\$0.64	\$2.05	\$8.85	\$1.09	\$0.00	\$0.00	\$73.14	\$90.23
4th year	80.00	\$39.06	\$15.88	\$10.46	\$0.64	\$2.34	\$8.85	\$1.25	\$0.00	\$0.00	\$78.48	\$98.00
Helper	70.00	\$34.17	\$15.88	\$10.46	\$0.64	\$2.05	\$8.85	\$1.09	\$0.00	\$0.00	\$73.14	\$90.23
Assistant Mechanic	80.00	\$39.06	\$15.88	\$10.46	\$0.64	\$2.34	\$8.85	\$1.25	\$0.00	\$0.00	\$78.48	\$98.00

Special Calculation Note : Other is Holiday Pay. Vacation calculated at 6%.

Ratio :

The total number of Helpers & Apprentices employed shall not exceed the number of Mechanics on any one job, except on jobs where (2) teams or more are working, (1) extra Helper or Apprentice may be employed for the first (2) teams and an extra Helper or Apprentice for each additional (3) teams.

- 1 Journeymen to 1 Apprentice
- 2 Journeymen to 5 Apprentice
- 3 Journeymen to 6 Apprentice

Special Jurisdictional Note :

Details :

Jurisdiction (* denotes special jurisdictional note) :

ADAMS, BROWN, BUTLER, CLERMONT, CLINTON, DARKE, GREENE, HAMILTON, HIGHLAND, MIAMI, MONTGOMERY, PREBLE, SCIOTO, SHELBY, WARREN

Prevailing Wage Rate Skilled Crafts

Name of Union: Glazier Local 387

Change # : LCN01-2023ibLoc387

Craft : Glazier Effective Date : 11/22/2023 Last Posted : 11/22/2023

	BHR		Fringe Benefit Payments					Irrevocable Fund		Total PWR	Overtime Rate	
			H&W	Pension	App Tr.	Vac.	Annuity	Other	LECET (*)	MISC (*)		
Classification												
Glazier	\$31.95		\$6.50	\$11.25	\$0.45	\$0.00	\$0.00	\$0.00	\$0.00	\$0.00	\$50.15	\$66.12
Apprentice												
	Percent											
1st Year	65.00	\$20.77	\$6.50	\$7.86	\$0.45	\$0.00	\$0.00	\$0.00	\$0.00	\$0.00	\$35.58	\$45.96
2nd Year	75.00	\$23.96	\$6.50	\$8.83	\$0.45	\$0.00	\$0.00	\$0.00	\$0.00	\$0.00	\$39.74	\$51.72
3rd Year	85.00	\$27.16	\$6.50	\$9.80	\$0.45	\$0.00	\$0.00	\$0.00	\$0.00	\$0.00	\$43.91	\$57.49
4th Year	95.00	\$30.35	\$6.50	\$10.77	\$0.45	\$0.00	\$0.00	\$0.00	\$0.00	\$0.00	\$48.07	\$63.25

Special Calculation Note : No special calculations for this skilled craft wage rate are required at this time.

Ratio :

Each employer may employ and train Apprentices in the following ratio to journeymen workers employed.
1 Journeymen to 1 Apprentice

Jurisdiction (* denotes special jurisdictional note) :

ADAMS, BROWN, BUTLER, CHAMPAIGN, CLARK, CLERMONT, CLINTON, DARKE, FAYETTE*, GREENE, HAMILTON, HIGHLAND, MIAMI, MONTGOMERY, PREBLE, WARREN

Special Jurisdictional Note : Fayette County: Eastern portion of route #41 being the dividing line between locals 372 and 387. Local 387 has jurisdiction of projects built on property which borders route #41 East.

Details :

Prevailing Wage Rate Skilled Crafts

Name of Union: Ironworker Local 44

Change # : LCN01-2023ibLoc44

Craft : Ironworker Effective Date : 06/01/2023 Last Posted : 05/31/2023

	BHR		Fringe Benefit Payments					Irrevocable Fund		Total PWR	Overtime Rate	
			H&W	Pension	App Tr.	Vac.	Annuity	Other	LECET (*)			MISC (*)
Classification												
Ironworker Reinforcing	\$32.87		\$8.90	\$9.50	\$0.60	\$0.00	\$4.30	\$0.20	\$0.00	\$0.00	\$56.37	\$72.80
Structural	\$32.37		\$8.90	\$9.50	\$0.60	\$0.00	\$4.30	\$0.20	\$0.00	\$0.00	\$55.87	\$72.05
Ornamental	\$32.37		\$8.90	\$9.50	\$0.60	\$0.00	\$4.30	\$0.20	\$0.00	\$0.00	\$55.87	\$72.05
Machine Mover/Rigger	\$32.37		\$8.90	\$9.50	\$0.60	\$0.00	\$4.30	\$0.20	\$0.00	\$0.00	\$55.87	\$72.05
Conveyer Mechanic	\$32.37		\$8.90	\$9.50	\$0.60	\$0.00	\$4.30	\$0.20	\$0.00	\$0.00	\$55.87	\$72.05
Maintenance/Heavy Hwy	\$32.37		\$8.90	\$9.50	\$0.60	\$0.00	\$4.30	\$0.20	\$0.00	\$0.00	\$55.87	\$72.05
Welder A	\$32.62		\$8.90	\$9.50	\$0.60	\$0.00	\$4.30	\$0.20	\$0.00	\$0.00	\$56.12	\$72.43
Welder B	\$32.87		\$8.90	\$9.50	\$0.60	\$0.00	\$4.30	\$0.20	\$0.00	\$0.00	\$56.37	\$72.80
Sheeter	\$32.37		\$8.90	\$9.50	\$0.60	\$0.00	\$4.30	\$0.20	\$0.00	\$0.00	\$55.87	\$72.05
Fence Erector	\$30.75		\$8.90	\$9.50	\$0.60	\$0.00	\$4.30	\$0.20	\$0.00	\$0.00	\$54.25	\$69.62
Ironworker	\$32.37		\$8.90	\$9.50	\$0.60	\$0.00	\$4.30	\$0.20	\$0.00	\$0.00	\$55.87	\$72.05
Apprentice	Percent											
Apprentice												
1st yr A	60.00	\$19.72	\$8.90	\$9.50	\$0.60	\$0.00	\$1.08	\$0.20	\$0.00	\$0.00	\$40.00	\$49.86
1st yr B	65.00	\$21.37	\$8.90	\$9.50	\$0.60	\$0.00	\$1.08	\$0.20	\$0.00	\$0.00	\$41.65	\$52.33
2nd yr A	70.00	\$23.01	\$8.90	\$9.50	\$0.60	\$0.00	\$1.08	\$0.20	\$0.00	\$0.00	\$43.29	\$54.79
2nd yr B	75.00	\$24.65	\$8.90	\$9.50	\$0.60	\$0.00	\$1.08	\$0.20	\$0.00	\$0.00	\$44.93	\$57.26
3rd yr A	80.00	\$26.30	\$8.90	\$9.50	\$0.60	\$0.00	\$2.15	\$0.20	\$0.00	\$0.00	\$47.65	\$60.79
3rd yr B	85.00	\$27.94	\$8.90	\$9.50	\$0.60	\$0.00	\$2.15	\$0.20	\$0.00	\$0.00	\$49.29	\$63.26
4th yr A	90.00	\$29.58	\$8.90	\$9.50	\$0.60	\$0.00	\$3.23	\$0.20	\$0.00	\$0.00	\$52.01	\$66.80
4th yr B	95.00	\$31.23	\$8.90	\$9.50	\$0.60	\$0.00	\$3.23	\$0.20	\$0.00	\$0.00	\$53.66	\$69.27
4th yr C	100.00	\$32.87	\$8.90	\$9.50	\$0.60	\$0.00	\$3.23	\$0.20	\$0.00	\$0.00	\$55.30	\$71.73

Special Calculation Note : Other is Impact Fund Training

Ratio :

Jurisdiction (* denotes special jurisdictional note) :

1 Journeymen to 1 Apprentice
2 Journeymen to 2 Apprentice
10 Journeymen to 4 Apprentices

ADAMS*, BROWN, BUTLER*, CLERMONT,
CLINTON*, HAMILTON, HIGHLAND*, WARREN*

Special Jurisdictional Note : Adams County Twps included: Bratton, Scott, Winchester, Wayne. Butler County Twps included: Oxford, St. Clair, Fairfield, Morgan, Liberty, Union, Ross, Reily, Hanover, West Chester. In Clinton County, Manchester and South West Borrow. Highland County Twps included: Dotson, Salem, Clay, White Oak, Hamer, New Market, Concord, Jackson, Washington. Warren County Twps included: Harlan, Deerfield, Hamilton.

Details :

Structural Iron Work but not limited to: field fabrication, all loading to and including the erecting, rigging, assembly, dismantling, placing, temporary and permanent securing by any means of all structural iron, steel, ornamental lead, bronze, brass, copper, aluminum, glass all ferrous and non ferrous metal and composite material, precast prestressed and post-stressed concrete structures. Bridges and bridge rails, bridge viaducts, bucks bulkheads, bumper and bumper post, canopies and unistrut canopies, corrugated ferrous and non ferrous sheets when attached to steel frames, columns, beams, bar-joists, trusses, grinders, roof decking, electrical supports, elevator cars, elevator fronts and enclosures, erection of steel towers, flag poles, gymnasium equipment, stadium and arena seating, jail cell work, jail cell beds, benches, bunks, chairs, tables, mirrors, jail cell access doors, rigging and installation of machinery and equipment (erecting, aligning, anchoring and dismantling, erection and dismantling of tower cranes, derrick monorail systems, Chicago booms, overhead cranes, gantries, material and personnel hoists, tanks, hoppers and conveyors. All pre-engineered metal buildings and their entirety including siding, roofing, gutters, downspouts and erection of all.

Reinforcing Iron Work but not limited to: Any work in connection with field fabrication, handling, racking, sorting, cutting, bending, hoisting, placing, burning, welding and tying of all materials used to reinforce concrete construction, except that loading and unloading by hand and carrying to a centralized point adjacent to or upon site of the project on which such materials are to be used. Realigning of reinforcing iron, wire mesh placing, bricking, pulling and similar reinforcing materials, placing steel dowels, as well as refastening and resetting same while concrete is being poured. Reinforcing steel and wire mesh in roadways and sidewalks in connection with building construction, also erection and fabrication of preconnection with building construction, also erection and fabrication of prestressed and precast joist, beams, columns, and slabs, walls, roofs, tanks, manholes, trenches and covers. The handling and placing of "J" or Jack bars on slip form construction; the placing of all clips, bolts, steel rods and wire fabric or mesh pertaining to gunite construction; the placing of steel-tex or paper-back mesh used for reinforcing and placing wire mesh to reinforce gypsum roof construction. Metal decking similar "corruflex" used for floor forms over metal or concrete supports whether welded or clipped. Post tension. All loading and unloading, hoisting, placing and tying of all post tensioning cables. Wrecking of cones, wedging of tendons, stressing, cutting and repairing.

Ornamental Iron Work but not limited to: all work in connection with field fabrication, handling including loading/off loading, sorting, cutting, fastening, anchoring, bending, hoisting, placing, burning, welding, and tying, dismantling of all materials used in miscellaneous iron or steel, for stairs, hand railings, rolling doors, rolling gates, rolling shutters, fence, windows, curtain wall, erection and welding of all metal, sash, architectural and ornamental treatments, but not necessarily limited to all sizes and types of ornamental, steel iron, lead, bronze, brass, copper, aluminum, all ferrous and non ferrous metals and composite materials

Fence Erector Iron Worker but not limited to: All work in connection with the field fabrication and erection of chain link fence, which includes but not limited to the loading and of the fence fabric and posts also the installation of the above.

Prevailing Wage Rate Skilled Crafts

Name of Union: Ironworker Local 290

Change # : LCN01-2024ibLoc290

Craft : Ironworker Effective Date : 06/05/2024 Last Posted : 06/05/2024

	BHR		Fringe Benefit Payments					Irrevocable Fund		Total PWR	Overtime Rate	
			H&W	Pension	App Tr.	Vac.	Annuity	Other	LECET (*)			MISC (*)
Classification												
Ironworker Structural	\$35.39		\$9.20	\$9.50	\$0.65	\$0.00	\$5.00	\$0.01	\$0.00	\$0.00	\$59.75	\$77.45
Welder	\$35.39		\$9.20	\$9.50	\$0.65	\$0.00	\$5.00	\$0.01	\$0.00	\$0.00	\$59.75	\$77.45
Fence Erector	\$35.39		\$9.20	\$9.50	\$0.65	\$0.00	\$5.00	\$0.01	\$0.00	\$0.00	\$59.75	\$77.45
Reinforcing Rods	\$35.39		\$9.20	\$9.50	\$0.65	\$0.00	\$5.00	\$0.01	\$0.00	\$0.00	\$59.75	\$77.45
Machinery Mover	\$35.39		\$9.20	\$9.50	\$0.65	\$0.00	\$5.00	\$0.01	\$0.00	\$0.00	\$59.75	\$77.45
Sheeter	\$35.39		\$9.20	\$9.50	\$0.65	\$0.00	\$5.00	\$0.01	\$0.00	\$0.00	\$59.75	\$77.45
Metal Building Erector	\$35.39		\$9.20	\$9.50	\$0.65	\$0.00	\$5.00	\$0.01	\$0.00	\$0.00	\$59.75	\$77.45
Rigger & Erector	\$35.39		\$9.20	\$9.50	\$0.65	\$0.00	\$5.00	\$0.01	\$0.00	\$0.00	\$59.75	\$77.45
Apprentice	Percent											
1st Year	64.22	\$22.73	\$9.20	\$9.50	\$0.65	\$0.00	\$3.50	\$0.01	\$0.00	\$0.00	\$45.59	\$56.95
2nd Year	74.22	\$26.27	\$9.20	\$9.50	\$0.65	\$0.00	\$3.50	\$0.01	\$0.00	\$0.00	\$49.13	\$62.26
3rd Year	84.22	\$29.81	\$9.20	\$9.50	\$0.65	\$0.00	\$3.50	\$0.01	\$0.00	\$0.00	\$52.67	\$67.57
4th Year	94.24	\$33.35	\$9.20	\$9.50	\$0.65	\$0.00	\$3.50	\$0.01	\$0.00	\$0.00	\$56.21	\$72.89

Special Calculation Note : Other is for Industry Fund.

Ratio :
1 Journeyman to 1 Apprentice

Jurisdiction (* denotes special jurisdictional note) :
ALLEN*, AUGLAIZE, BUTLER*, CHAMPAIGN*, CLARK, CLINTON, DARKE, FAYETTE*, GREENE, HARDIN*, HIGHLAND*, LOGAN*, MADISON*, MERCER*, MIAMI, MONTGOMERY, PREBLE, SHELBY, VAN WERT*, WARREN*

Special Jurisdictional Note : Allen County Twps included are: Auglaize, Perry, Shawnee, Amanda, Spencer, Marion, Sugar Creek, American, Bath, Jackson.

Butler County Twps included are: Milford, Wayne, Madison, Lemon.

Champaign County Twps included are: Union, Urbana, Jackson, Concord, Salem, Mad River, Johnson, Harrison, Adams.

Fayette County Twps included are: Green, Jasper, Concord, Jefferson.

Hardin County Twps included are: Round Head, Marion, Liberty.

Highland County Twps included are: Fairfield, Penn, Union, Marshall, Liberty, Paint, Brush Creek.

Logan County Twps included are: Richland, Stokes, Bloomfield, Washington, Harrison, McArthur, Lake, Liberty, Pleasant, Miami.

Madison County Twps included are: Stokes.

Mercer County Twps included are: Dublin, Washington, Jefferson, Recovery, Gibson, Union, Liberty, Butler, Granville, Center,

Hopewell, Franklin, Marion.

VanWert County Twps included are: Jennings.

Warren County Twps included are: Franklin, Clear Creek, Turtle Creek, Wayne, Massie, Washington, Salem, Union.

Details :

Structural Iron Work but not limited to: field fabrication, all loading to and including the erecting, rigging, assembly, dismantling, placing, temporary and permanent securing by any means of all structural iron, steel, ornamental lead, bronze, brass, copper, aluminum, glass all ferrous and non ferrous metal and composite material, precast prestressed and post-stressed concrete structures. Bridges and bridge rails, bridge viaducts, bucks bulkheads, bumper and bumper post, canopies and unistrut canopies, corrugated ferrous and non ferrous sheets when attached to steel frames, columns, beams, bar-joists, trusses, grinders, roof decking, electrical supports, elevator cars, elevator fronts and enclosures, erection of steel towers, flag poles, gymnasium equipment, stadium and arena seating, jail cell work, jail cell beds, benches, bunks, chairs, tables, mirrors, jail cell access doors, rigging and installation of machinery and equipment (erecting, aligning, anchoring and dismantling, erection and dismantling of tower cranes, derrick monorail systems, Chicago booms, overhead cranes, gantries, material and personnel hoists, tanks, hoppers and conveyors. All pre-engineered metal buildings and their entirety including siding, roofing, gutters, downspouts and erection of all.

Ornamental Iron Work but not limited to: all work in connection with field fabrication, handling including loading/off loading, sorting, cutting, fastening, anchoring, bending, hoisting, placing, burning, welding, and tying, dismantling of all materials used in miscellaneous iron or steel, for stairs, hand railings, rolling doors, rolling gates, rolling shutters, fence, windows, curtain wall, erection and welding of all metal, sash, architectural and ornamental treatments, but not necessarily limited to all sizes and types of ornamental, steel iron, lead, bronze, brass, copper, aluminum, all ferrous and non ferrous metals and composite materials

Fence Erector Iron Worker but not limited to: All work in connection with the field fabrication and erection of chain link fence, which includes but not limited to the loading and of the fence fabric and posts also the installation of the above.

Reinforcing Iron Worker but not limited to: work in connection with field fabrication, handling, racking, sorting, cutting, bending, hoisting, placing, burning, welding and tying all materials used to reinforce concrete construction, except loading and unloading by hand. Re-aligning of the reinforced iron, wire mesh placing, bricking, pulling and similar reinforcing materials, placing steel dowels, as well as re-fasten. Reinforcing steel and wire mesh in roadways and sidewalks in connection with building construction. Also, erection and fabrication of pre-connection with building construction, also erection and fabrication of pre-stressed and precast joists, beams, columns, slabs; walls, roofs, tanks, manholes, trenches and covers. Handling of "J" or jack bars on slip forms. Metal decking similar to "corruflex" when used for floor forms over metal or concrete supports either welded or clipped. Post tension, all loading and unloading, hoisting, placing and tying of all post tensioning cables. Placing and tying of all duct work in bonded post tension. All of the wrecking of cones, wedging of the tendons, stressing, cutting, repairing and grouting of bonded post tension.

Prevailing Wage Rate

Skilled Crafts

Name of Union: Labor HevHwy 3

Change # : LCN01-2024lbLocalHevHwy3

Craft : Laborer Group 1 Effective Date : 05/01/2024 Last Posted : 05/01/2024

	BHR		Fringe Benefit Payments					Irrevocable Fund		Total PWR	Overtime Rate	
			H&W	Pension	App Tr.	Vac.	Annuity	Other	LECET (*)			MISC (*)
Classification												
Laborer Group 1	\$35.52		\$8.40	\$4.15	\$0.45	\$0.00	\$1.50	\$0.00	\$0.10	\$0.00	\$50.12	\$67.88
Group 2	\$35.69		\$8.40	\$4.15	\$0.45	\$0.00	\$1.50	\$0.00	\$0.10	\$0.00	\$50.29	\$68.13
Group 3	\$36.02		\$8.40	\$4.15	\$0.45	\$0.00	\$1.50	\$0.00	\$0.10	\$0.00	\$50.62	\$68.63
Group 4	\$36.47		\$8.40	\$4.15	\$0.45	\$0.00	\$1.50	\$0.00	\$0.10	\$0.00	\$51.07	\$69.30
Watch Person	\$28.25		\$8.40	\$4.15	\$0.45	\$0.00	\$1.50	\$0.00	\$0.10	\$0.00	\$42.85	\$56.98
Apprentice	Percent											
0-1000 hrs	60.00	\$21.31	\$8.40	\$4.15	\$0.45	\$0.00	\$1.50	\$0.00	\$0.10	\$0.00	\$35.91	\$46.57
1001-2000 hrs	70.00	\$24.86	\$8.40	\$4.15	\$0.45	\$0.00	\$1.50	\$0.00	\$0.10	\$0.00	\$39.46	\$51.90
2001-3000 hrs	80.00	\$28.42	\$8.40	\$4.15	\$0.45	\$0.00	\$1.50	\$0.00	\$0.10	\$0.00	\$43.02	\$57.22
3001-4000 hrs	90.00	\$31.97	\$8.40	\$4.15	\$0.45	\$0.00	\$1.50	\$0.00	\$0.10	\$0.00	\$46.57	\$62.55
More than 4000 hrs	100.00	\$35.52	\$8.40	\$4.15	\$0.45	\$0.00	\$1.50	\$0.00	\$0.10	\$0.00	\$50.12	\$67.88

Special Calculation Note : Watchmen have no Apprentices. Tunnel Laborer rate with air-pressurized add \$1.00 to the above wage rate.

Ratio :

1 Journeymen to 1 Apprentice
3 Journeymen to 1 Apprentice thereafter

Jurisdiction (* denotes special jurisdictional note) :

ADAMS, ALLEN, ASHLAND, ATHENS, AUGLAIZE, BELMONT, BROWN, BUTLER, CARROLL, CHAMPAIGN, CLARK, CLERMONT, CLINTON, COLUMBIANA, COSHOCTON, CRAWFORD, DARKE, DEFIANCE, DELAWARE, FAIRFIELD, FAYETTE, FRANKLIN, FULTON, GALLIA, GREENE, GUERNSEY, HAMILTON, HANCOCK, HARDIN, HARRISON, HENRY, HIGHLAND, HOCKING, HOLMES, JACKSON, JEFFERSON, KNOX, LAWRENCE, LICKING, LOGAN, MADISON, MARION, MEIGS, MERCER, MIAMI, MONROE, MONTGOMERY, MORGAN, MORROW, MUSKINGUM, NOBLE, PAULDING, PERRY, PICKAWAY, PIKE, PREBLE, PUTNAM, RICHLAND, ROSS, SCIOTO, SENECA, SHELBY, TUSCARAWAS, UNION, VAN WERT, VINTON, WARREN, WASHINGTON, WAYNE, WILLIAMS, WYANDOT

Special Jurisdictional Note : Hod Carriers and Common Laborers - Heavy, Highway, Sewer, Waterworks, Utility, Airport, Railroad, Industrial and Building Site, Sewer Plant, Waste Water Treatment Facilities Construction

Details :

Group 1

Laborer (Construction); Plant Laborer or Yardman, Right-of-way Laborer, Landscape Laborer, Highway Lighting Worker, Signalization Worker, (Swimming) Pool Construction Laborer, Utility Man, *Bridge Man, Handyman, Joint Setter, Flagperson, Carpenter Helper, Waterproofing Laborer, Slurry Seal, Seal Coating, Surface Treatment or Road Mix Laborer, Riprap Laborer & Grouter, Asphalt Laborer, Dump Man (batch trucks), Guardrail & Fence Installer, Mesh Handler & Placer, Concrete Curing Applicator, Scaffold Erector, Sign Installer, Hazardous Waste (level D), Diver Helper, Zone Person and Traffic Control.

*Bridge Man will perform work as per the October 31, 1949, memorandum on concrete forms, by and between the United Brotherhood of Carpenters and Joiners of America and the Laborers' International Union of North America, which states in; "the moving, cleaning, oiling and carrying to the next point of erection, and the stripping of forms which are not to be re-used, and forms on all flat arch work shall be done by members of the Laborers' International Union of North America."

Group 2

Asphalt Raker, Screwman or Paver, Concrete Puddler, Kettle Man (pipeline), All Machine-Driven Tools (Gas, Electric, Air), Mason Tender, Brick Paver, Mortar Mixer, Skid Steer, Sheeting & Shoring Person, Surface Grinder Person, Screedperson, Water Blast, Hand Held Wand, Power Buggy or Power Wheelbarrow, Paint Striper, Plastic fusing Machine Operator, Rodding Machine Operator, Pug Mill Operator, Operator of All Vacuum Devices Wet or Dry, Handling of all Pumps 4 inches and under (gas, air or electric), Diver, Form Setter, Bottom Person, Welder Helper (pipeline), Concrete Saw Person, Cutting with Burning Torch, Pipe Layer, Hand Spiker (railroad), Underground Person (working in sewer and waterline, cleaning, repairing and reconditioning). Tunnel Laborer (without air), Caisson, Cofferdam (below 25 feet deep), Air Track and Wagon Drill, Sandblaster Nozzle Person, Hazardous Waste (level B), ***Lead Abatement, Hazardous Waste (level C)

***Includes the erecting of structures for the removal, including the encapsulation and containment of Lead abatement process.

Group 3

Blast and Powder Person, Muckers will be defined as shovel men working directly with the miners, Wrencher (mechanical joints & utility pipeline), Yarnier, Top Lander, Hazardous Waste (level A), Concrete Specialist, Curb Setter and Cutter, Grade Checker, Concrete Crew in Tunnels. Utility pipeline Tappers, Waterline, Caulker, Signal Person will receive the rate equal to the rate paid the Laborer classification for which the Laborer is signaling.

Group 4

Miner, Welder, Gunitite Nozzle Person

A.) The Watchperson shall be responsible to patrol and maintain a safe traffic zone including but not limited to barrels, cones, signs, arrow boards, message boards etc.

The responsibility of a watchperson is to see that the equipment, job and office trailer etc. are secure.

Prevailing Wage Rate Skilled Crafts

Name of Union: Labor Local 534 Building

Change # : LCN01-2024ibLoc534

Craft : Laborer Effective Date : 06/12/2024 Last Posted : 06/12/2024

	BHR		Fringe Benefit Payments					Irrevocable Fund		Total PWR	Overtime Rate	
			H&W	Pension	App Tr.	Vac.	Annuity	Other	LECET (*)			MISC (*)
Classification												
Laborer Group 1	\$32.49		\$8.40	\$4.15	\$0.45	\$0.00	\$1.50	\$0.00	\$0.10	\$0.00	\$47.09	\$63.34
Laborer Group 2	\$32.59		\$8.40	\$4.15	\$0.45	\$0.00	\$1.50	\$0.00	\$0.10	\$0.00	\$47.19	\$63.49
Laborer Group 3	\$32.69		\$8.40	\$4.15	\$0.45	\$0.00	\$1.50	\$0.00	\$0.10	\$0.00	\$47.29	\$63.64
Laborer Group 4	\$32.82		\$8.40	\$4.15	\$0.45	\$0.00	\$1.50	\$0.00	\$0.10	\$0.00	\$47.42	\$63.83
Laborer Group 5	\$33.07		\$8.40	\$4.15	\$0.45	\$0.00	\$1.50	\$0.00	\$0.10	\$0.00	\$47.67	\$64.20
Laborer Group 6	\$32.84		\$8.40	\$4.15	\$0.45	\$0.00	\$1.50	\$0.00	\$0.10	\$0.00	\$47.44	\$63.86
Laborer Group 7	\$32.04		\$8.40	\$4.15	\$0.45	\$0.00	\$1.50	\$0.00	\$0.10	\$0.00	\$46.64	\$62.66
Apprentice	Percent											
0-1000 hrs	80.00	\$25.99	\$8.40	\$4.15	\$0.45	\$0.00	\$1.50	\$0.00	\$0.10	\$0.00	\$40.59	\$53.59
1001-2000 hrs	85.00	\$27.62	\$8.40	\$4.15	\$0.45	\$0.00	\$1.50	\$0.00	\$0.10	\$0.00	\$42.22	\$56.02
2001-3000 hrs	90.00	\$29.24	\$8.40	\$4.15	\$0.45	\$0.00	\$1.50	\$0.00	\$0.10	\$0.00	\$43.84	\$58.46
3001-4000	95.00	\$30.87	\$8.40	\$4.15	\$0.45	\$0.00	\$1.50	\$0.00	\$0.10	\$0.00	\$45.47	\$60.90
4001+	100.00	\$32.49	\$8.40	\$4.15	\$0.45	\$0.00	\$1.50	\$0.00	\$0.10	\$0.00	\$47.09	\$63.34

Special Calculation Note : No special calculations for this skilled craft wage rate are required at this time.

Ratio :
1 Journeyman to 1 Apprentice
3 Journeyman to 1 Apprentice

Jurisdiction (* denotes special jurisdictional note) :
BUTLER, WARREN

Special Jurisdictional Note :

Details :
Note:

Group 1: Building & Common Laborer; All general laborers work including all forms of landscaping, Rough Rider - all pump's 4 inch or smaller, Small Pump Portable Generators-Bobcat to Cleanup, Firewatch and Monitor, (Safety Person)

Group 2: Asphalt Raker, Tamper, Smoother, Hand Air Pump, Hand air Tamper, Chisel, Power Tamper, Operator, Switch, Assemblies, Handling & Laying Precast Concrete Floors & Deck Tool Repairman.

Group 3: Concrete Specialist; Skid Steers (with attachments to perform Laborer's duties) Jack Hammer * Concrete Busterman, Barco Tamper Man, Power Georgia Buggy Man, Power Sweeper Man, Vibrator, Concrete Saw Man, Rail Spikers, Acetylene Burner, Pipelayers, Bos'n Cradleman, Bottom Man, Chipping Hammer Grade Checker, Radio Operator, Form Cleanout & blowout Man, Red Concrete Coloring Man (Electrical Safety)

Group 4: Mason Tender, Mortar Mixers & Scaffold Builders

Group 5: Fork Lift for Mason, all work involving Refractory Materials Including Demolition of Refractory Materials. Asbestos Removal and Hazardous Waste Removal (handling, control, removal abatement, encapsulation or disposal of asbestos & hazardous waste),

Group 6: Gunnite Man, Sand Blaster, Concrete & Grout Pump & Hose Man, Blast Trac, Miners & Muckers, Free Air, Powderman or Blaster, Mortar or Gypsum Machineman, Welder, Scuba Diver.

Group 7: Watchman & Tool Checker/Toolroom Man

Prevailing Wage Rate Skilled Crafts

Name of Union: Operating Engineers - Building Local 18 - Zone III

Change # : LCN01-2024IbLoc18zone3

Craft : Operating Engineer Effective Date : 06/05/2024 Last Posted : 06/05/2024

	BHR		Fringe Benefit Payments					Irrevocable Fund		Total PWR	Overtime Rate	
			H&W	Pension	App Tr.	Vac.	Annuity	Other	LECET (*)			MISC (*)
Classification												
Operator Group A	\$44.14		\$9.26	\$6.25	\$0.90	\$0.00	\$0.00	\$0.09	\$0.00	\$0.10	\$60.74	\$82.81
Operator Group B	\$44.02		\$9.26	\$6.25	\$0.90	\$0.00	\$0.00	\$0.09	\$0.00	\$0.10	\$60.62	\$82.63
Operator Group C	\$42.98		\$9.26	\$6.25	\$0.90	\$0.00	\$0.00	\$0.09	\$0.00	\$0.10	\$59.58	\$81.07
Operator Group D	\$41.80		\$9.26	\$6.25	\$0.90	\$0.00	\$0.00	\$0.09	\$0.00	\$0.10	\$58.40	\$79.30
Operator Group E	\$36.34		\$9.26	\$6.25	\$0.90	\$0.00	\$0.00	\$0.09	\$0.00	\$0.10	\$52.94	\$71.11
Master Mechanic	\$45.14		\$9.26	\$6.25	\$0.90	\$0.00	\$0.00	\$0.09	\$0.00	\$0.10	\$61.74	\$84.31
Cranes & Mobile Concrete Pumps 150'-180'	\$44.64		\$9.26	\$6.25	\$0.90	\$0.00	\$0.00	\$0.09	\$0.00	\$0.10	\$61.24	\$83.56
Cranes & Mobile Concrete Pumps 180'-249'	\$45.14		\$9.26	\$6.25	\$0.90	\$0.00	\$0.00	\$0.09	\$0.00	\$0.10	\$61.74	\$84.31
Cranes & Mobile Concrete Pumps 249' and over	\$45.39		\$9.26	\$6.25	\$0.90	\$0.00	\$0.00	\$0.09	\$0.00	\$0.10	\$61.99	\$84.69
Apprentice	Percent											
1st Year	50.00	\$22.07	\$9.26	\$6.25	\$0.90	\$0.00	\$0.00	\$0.09	\$0.00	\$0.10	\$38.67	\$49.71
2nd Year	60.00	\$26.48	\$9.26	\$6.25	\$0.90	\$0.00	\$0.00	\$0.09	\$0.00	\$0.10	\$43.08	\$56.33
3rd Year	70.00	\$30.90	\$9.26	\$6.25	\$0.90	\$0.00	\$0.00	\$0.09	\$0.00	\$0.10	\$47.50	\$62.95
4th Year	80.00	\$35.31	\$9.26	\$6.25	\$0.90	\$0.00	\$0.00	\$0.09	\$0.00	\$0.10	\$51.91	\$69.57
Field Mechanic Trainee												
1st Year	50.00	\$22.07	\$9.26	\$6.25	\$0.90	\$0.00	\$0.00	\$0.09	\$0.00	\$0.10	\$38.67	\$49.71
2nd Year	60.00	\$26.48	\$9.26	\$6.25	\$0.90	\$0.00	\$0.00	\$0.09	\$0.00	\$0.10	\$43.08	\$56.33
3rd Year	70.00	\$30.90	\$9.26	\$6.25	\$0.90	\$0.00	\$0.00	\$0.09	\$0.00	\$0.10	\$47.50	\$62.95
4th Year	80.00	\$35.31	\$9.26	\$6.25	\$0.90	\$0.00	\$0.00	\$0.09	\$0.00	\$0.10	\$51.91	\$69.57

Special Calculation Note : Other: Education & Safety
Misc: National Training

Ratio :
For every (3) Operating Engineer Journeymen employed by the company there may be employed (1) Registered Apprentice or trainee Engineer through the referral when they are available. An apprentice,

Jurisdiction (* denotes special jurisdictional note) :
ADAMS, ALLEN, ASHLAND, ATHENS, AUGLAIZE, BELMONT, BROWN, BUTLER, CARROLL, CHAMPAIGN, CLARK, CLERMONT, CLINTON, COSHOCTON, CRAWFORD, DARKE,

while employed as part of a crew per Article VIII, paragraph 78, will not be subject to the apprenticeship ratios in this collective bargaining agreement

DEFIANCE, DELAWARE, FAIRFIELD, FAYETTE, FRANKLIN, FULTON, GALLIA, GREENE, GUERNSEY, HAMILTON, HANCOCK, HARDIN, HARRISON, HENRY, HIGHLAND, HOCKING, HOLMES, JACKSON, JEFFERSON, KNOX, LAWRENCE, LICKING, LOGAN, MADISON, MARION, MEIGS, MERCER, MIAMI, MONROE, MONTGOMERY, MORGAN, MORROW, MUSKINGUM, NOBLE, OTTAWA, PAULDING, PERRY, PICKAWAY, PIKE, PREBLE, PUTNAM, RICHLAND, ROSS, SANDUSKY, SCIOTO, SENECA, SHELBY, STARK, TUSCARAWAS, UNION, VAN WERT, VINTON, WARREN, WASHINGTON, WAYNE, WILLIAMS, WYANDOT

Special Jurisdictional Note :

Details :

Note: There will be a 10% increase for the apprentices on top of the percentages listed above provided they are operating mobile equipment. Mechanic Trainees will receive 10% increase if required to have CDL

Group A- Barrier Moving Machines; Boiler Operators or Compressor Operators, when compressor or boiler is mounted on crane (Piggyback Operation); Boom Trucks (all types); Cableways Cherry Pickers; Combination - Concrete Mixers & Towers; All Concrete Pumps with Booms; Cranes (all types); Compact Cranes, track or rubber over 4,000 pounds capacity; Cranes self-erecting, stationary, track or truck (all configurations); Derricks (all types); Draglines; Dredges (dipper, clam or suction) 3-man crew; Elevating Graders or Euclid Loaders; Floating Equipment; Forklift (rough terrain with winch/hoist); Gradalls; Helicopter Operators, hoisting building materials; Helicopter Winch Operators, Hoisting building materials; Hoes (All types); Hoists (with two or more drums in use); Horizontal Directional Drill; Hydraulic Gantry (lift system); Laser Finishing Machines; Laser Screed and like equipment; Lift Slab or Panel Jack Operators; Locomotives (all types); Maintenance Operator/Technician (Mechanic Operator/Technician and/or Welder); Mixers, paving (multiple drum); Mobile Concrete Pumps, with booms; Panelboards, (all types on site); Pile Drivers; Power Shovels; Prentice Loader; Rail Tamper (with automatic lifting and aligning device); Rotary Drills (all), used on caissons for foundations and sub-structure; Side Booms; Slip Form Pavers; Straddle Carriers (Building Construction on site); Trench Machines (over 24" wide); Tug Boats.

Group B - Articulating/end dumps (minus \$4.00/hour from Group B rate); Asphalt Pavers; Bobcat-type and/or skid steer loader with hoe attachment greater than 7000 lbs.; Bulldozers; CMI type Equipment; Concrete Saw, Vermeer-type; Endloaders; Hydro Milling Machine; Kolman-type Loaders (Dirt Loading); Lead Greasemen; Mucking Machines; Pettibone-Rail Equipment; Power Graders; Power Scoops; Power Scrapers; Push Cats; Rotomills (all), grinders and planers of all types.

Group C - A-Frames; Air Compressors, Pressurizing Shafts or Tunnels; All Asphalt Rollers; Bobcat-type and/or Skid Steer Loader with or without attachments; Boilers (15 lbs. pressure and over); All Concrete Pumps (without booms with 5 inch system); Fork Lifts (except masonry); Highway Drills - all types (with integral power); Hoists (with one drum); House Elevators (except those automatic call button controlled), Buck Hoists, Transport Platforms, Construction Elevators; Hydro Vac/Excavator (when a second person is needed, the rate of pay will be "Class E"); Man Lifts; Material hoist/elevators; Mud Jacks; Pressure Grouting; Pump Operators (installing or operating Well Points or other types of Dewatering Systems); Pumps (4 inches and over discharge); Railroad Tie (Inserter/Remover); Rotovator (Lime-Soil Stabilizer); Submersible Pumps (4" and over discharge); Switch & Tie Tampers (without lifting and aligning device); Trench Machines (24" and under); Utility Operators.

Group D - Backfillers and Tampers; Ballast Re-locator; Batch Plant Operators; Bar and Joint Installing Machines; Bull Floats; Burlap and Curing Machines; Clefplanes; Compressors, on building construction; Concrete Mixers, more than one bag capacity; Concrete Mixers, one bag capacity (side loaders); All Concrete Pumps (without boom with 4" or smaller system); Concrete Spreader; Conveyors, used for handling building materials; Crushers; Deckhands; Drum Fireman (in asphalt plants); Farm type tractors pulling attachments; Finishing Machines; Form Trenchers; Generators; Guniting Machines; Hydro-seeders; Pavement Breakers (hydraulic or cable); Post Drivers; Post Hole Diggers; Pressure Pumps (over 1/2" discharge); Road Widening Trenchers; Rollers (except asphalt); Self-propelled sub-graders; Shotcrete Machines; Tire Repairmen; Tractors, pulling sheepsfoot post roller or grader; VAC/ALLS; Vibratory Compactors, with integral power; Welders.

Group E - Allen Screed Paver (concrete); Boilers (less than 15 lbs. pressure); Cranes-Compact, track or rubber (under 4,000 pounds capacity); Directional Drill "Locator"; Fueling and greasing +\$3.00; Inboard/outboard Motor Boat Launches; Light Plant Operators; Masonry Fork Lifts; Oilers/Helpers; Power Driven Heaters (oil fired); Power Scrubbers; Power Sweepers; Pumps (under 4 inch discharge); Signalperson, Submersible Pumps (under 4" discharge).

Master Mechanics - Master Mechanic

Cranes 150' - 180' - Boom & Jib 150 - 180 feet

Cranes 180' - 249' - Boom & Jib 180 - 249 feet

Cranes 250' and over - Boom & Jib 250-feet or over

Prevailing Wage Rate

Skilled Crafts

Name of Union: Operating Engineers - HevHwy Zone II

Change # : LCN01-2024IbLoc18hevhwyl

Craft : Operating Engineer Effective Date : 06/05/2024 Last Posted : 06/05/2024

	BHR		Fringe Benefit Payments					Irrevocable Fund		Total PWR	Overtime Rate	
			H&W	Pension	App Tr.	Vac.	Annuity	Other	LECET (*)			MISC (*)
Classification												
Operator Class A	\$44.14		\$9.26	\$6.25	\$0.90	\$0.00	\$0.00	\$0.09	\$0.00	\$0.10	\$60.74	\$82.81
Operator Class B	\$44.02		\$9.26	\$6.25	\$0.90	\$0.00	\$0.00	\$0.09	\$0.00	\$0.10	\$60.62	\$82.63
Operator Class C	\$42.98		\$9.26	\$6.25	\$0.90	\$0.00	\$0.00	\$0.09	\$0.00	\$0.10	\$59.58	\$81.07
Operator Class D	\$41.80		\$9.26	\$6.25	\$0.90	\$0.00	\$0.00	\$0.09	\$0.00	\$0.10	\$58.40	\$79.30
Operator Class E	\$36.34		\$9.26	\$6.25	\$0.90	\$0.00	\$0.00	\$0.09	\$0.00	\$0.10	\$52.94	\$71.11
Master Mechanic	\$45.14		\$9.26	\$6.25	\$0.90	\$0.00	\$0.00	\$0.09	\$0.00	\$0.10	\$61.74	\$84.31
Crane and Mobile Concrete Pump 150' - 179'	\$44.64		\$9.26	\$6.25	\$0.90	\$0.00	\$0.00	\$0.09	\$0.00	\$0.10	\$61.24	\$83.56
Crane and Mobile Concrete Pump 180' - 249'	\$45.14		\$9.26	\$6.25	\$0.90	\$0.00	\$0.00	\$0.09	\$0.00	\$0.10	\$61.74	\$84.31
Crane and Mobile Concrete Pump 250' and Over	\$45.39		\$9.26	\$6.25	\$0.90	\$0.00	\$0.00	\$0.09	\$0.00	\$0.10	\$61.99	\$84.69
Apprentice	Percent											
1st Year	50.00	\$22.07	\$9.26	\$6.25	\$0.90	\$0.00	\$0.00	\$0.09	\$0.00	\$0.10	\$38.67	\$49.71
2nd Year	60.00	\$26.48	\$9.26	\$6.25	\$0.90	\$0.00	\$0.00	\$0.09	\$0.00	\$0.10	\$43.08	\$56.33
3rd Year	70.00	\$30.90	\$9.26	\$6.25	\$0.90	\$0.00	\$0.00	\$0.09	\$0.00	\$0.10	\$47.50	\$62.95
4th Year	80.00	\$35.31	\$9.26	\$6.25	\$0.90	\$0.00	\$0.00	\$0.09	\$0.00	\$0.10	\$51.91	\$69.57
Field Mech Trainee Class 2												
1st year	50.00	\$22.07	\$9.26	\$6.25	\$0.90	\$0.00	\$0.00	\$0.09	\$0.00	\$0.10	\$38.67	\$49.71
2nd year	60.00	\$26.48	\$9.26	\$6.25	\$0.90	\$0.00	\$0.00	\$0.09	\$0.00	\$0.10	\$43.08	\$56.33
3rd year	70.00	\$30.90	\$9.26	\$6.25	\$0.90	\$0.00	\$0.00	\$0.09	\$0.00	\$0.10	\$47.50	\$62.95
4th year	80.00	\$35.31	\$9.26	\$6.25	\$0.90	\$0.00	\$0.00	\$0.09	\$0.00	\$0.10	\$51.91	\$69.57

Special Calculation Note : Other: Education & Safety Fund

Misc: National Training

Ratio :

For every (3) Operating Engineer Journeymen employed by the company, there may be employed (1) Registered Apprentice or Trainee Engineer through the referral when they are available. An

Jurisdiction (* denotes special jurisdictional note) :

ADAMS, ALLEN, ASHLAND, ATHENS, AUGLAIZE, BELMONT, BROWN, BUTLER, CARROLL, CHAMPAIGN, CLARK, CLERMONT, CLINTON, COSHOCTON, CRAWFORD, DARKE,

Apprentice, while employed as part of a crew per Article VIII, paragraph 65 will not be subject to the apprenticeship ratios in this collective bargaining agreement

DEFIANCE, DELAWARE, FAIRFIELD, FAYETTE, FRANKLIN, FULTON, GALLIA, GREENE, GUERNSEY, HAMILTON, HANCOCK, HARDIN, HARRISON, HENRY, HIGHLAND, HOCKING, HOLMES, HURON, JACKSON, JEFFERSON, KNOX, LAWRENCE, LICKING, LOGAN, LUCAS, MADISON, MARION, MEIGS, MERCER, MIAMI, MONROE, MONTGOMERY, MORGAN, MORROW, MUSKINGUM, NOBLE, OTTAWA, PAULDING, PERRY, PICKAWAY, PIKE, PREBLE, PUTNAM, RICHLAND, ROSS, SANDUSKY, SCIOTO, SENECA, SHELBY, STARK, TUSCARAWAS, UNION, VAN WERT, VINTON, WARREN, WASHINGTON, WAYNE, WILLIAMS, WOOD, WYANDOT

Special Jurisdictional Note :

Details :

**Apprentices will receive a 10% increase on top of the percentages listed above provided they are operating mobile equipment. Mechanic Trainees will receive 10% increase if they are required to have CDL.

Class A - Air Compressors on Steel Erection; Asphalt Plant Engineers (Cleveland District Only); Barrier Moving Machine; Boiler Operators, Compressor Operators, or Generators, when mounted on a rig; Boom Trucks (all types); Cableways; Cherry Pickers; Combination- Concrete Mixers & Towers; Concrete Plants (over 4 yd capacity); Concrete Pumps; Cranes (all types); Compact Cranes track or rubber over 4,000 pounds capacity; Cranes self-erecting stationary, track or truck; Derricks (all types); Draglines; Dredges dipper, clam or suction; Elevating Graders or Euclid Loaders; Floating Equipment (all types); Gradalls; Helicopter Crew (Operator- hoist or winch); Hoes (all types); Hoisting Engines; Hoisting Engines, on shaft or tunnel work; Hydraulic Gantry (lifting system); Industrial-type Tractors; Jet Engine Dryer (D8 or D9) diesel Tractors; Locomotives (standard gauge); Maintenance Operators/Technicians (class A); Mixers, paving (single or double drum); Mucking Machines; Multiple Scrapers; Piledriving Machines (all types); Power Shovels, Prentice Loader; Quad 9 (double pusher); Rail Tamper (with automatic lifting and aligning device); Refrigerating Machines (freezer operation); Rotary Drills, on caisson work; Rough Terrain Fork Lift with winch/hoist; Side Booms; Slip Form Pavers; Survey Crew Party Chiefs; Tower Derricks; Tree Shredders; Trench Machines (over 24" wide); Truck Mounted Concrete Pumps; Tug Boats; Tunnel Machines and /or Mining Machines; Wheel Excavators.

Class B - Asphalt Pavers; Automatic Subgrade Machines, self-propelled (CMI-type); Bobcat-type and /or Skid Steer Loader with hoe attachment greater than 7000 lbs.; Boring Machine Operators (more than 48 inches); Bulldozers; Concrete Saws, Vermeer type; Endloaders; Horizontal Directional Drill (50,000 ft. lbs. thrust and over); Hydro Milling Machine; Kolman-type Loaders (production type-dirt); Lead Greasemen; Lighting and Traffic Signal Installation Equipment includes all groups or classifications; Maintenance Operators/Technicians, Class B; Material Transfer Equipment (shuttle buggy) Asphalt; Pettibone-Rail Equipment; Power Graders; Power Scrapers; Push Cats; Rotomills (all), Grinders and Planners of all types, Groovers (excluding walk-behinds); Trench Machines (24 inch wide and under).

Class C - A-Frames; Air Compressors, on tunnel work (low Pressure); Articulating/straight bed end dumps if assigned (minus \$4.00 per hour); Asphalt Plant Engineers (Portage and Summit Counties only); Bobcat-type and/or skid steer loader with or without attachments; Drones; Highway Drills (all types); HydroVac/Excavator (when a second person is needed, the rate of pay will be "Class E"); Locomotives (narrow gauge); Material Hoist/Elevators; Mixers, concrete (more than one bag capacity); Mixers, one bag capacity (side loader); Power Boilers (over 15 lbs. pressure); Pump Operators (installing or operating well Points); Pumps (4 inch and over discharge); Railroad Tie Inserter/Remover; Rollers, Asphalt; Rotovator (lime-soil Stabilizer); Switch & Tie Tampers (without lifting and aligning device); Utilities Operators, (small equipment); Welding Machines and Generators.

Class D - Backfillers and Tampers; Ballast Re-locator; Bar and Joint Installing Machines; Batch Plant Operators; Boring Machine Operators (48 inch or less); Bull Floats; Burlap and Curing Machines; Concrete Plants (capacity 4 yds. and under); Concrete Saws (multiple); Conveyors (highway); Crushers; Deckhands; Farm type tractors, with attachments (highway); Finishing Machines; Firemen, Floating Equipment (all types); Fork Lifts (highway), except masonry; Form Trenchers; Hydro Hammers; Hydro Seeders; Pavement Breakers (hydraulic or cable); Plant Mixers; Post Drivers; Post Hole Diggers; Power Brush Burners; Power Form Handling Equipment; Road Widening Trenchers; Rollers (brick, grade, macadam); Self-Propelled Power Spreaders; Self-Propelled Sub-Graders; Steam Firemen; Survey Instrument men; Tractors, pulling sheepsfoot rollers or graders; Vibratory Compactors, with integral power.

Class E - Compressors (portable, Sewer, Heavy and Highway); Cranes-Compact, track or rubber under 4,000 pound capacity; Drum Firemen (asphalt plant); Fueling and greasing (Primary Operator with Specialized CDL Endorsement Add \$3.00/hr); Generators; Inboard-Outboard Motor Boat Launches; Masonry Fork Lifts; Oil Heaters (asphalt plant); Oilers/Helpers; Power Driven Heaters (oil fired); Power Scrubbers; Power Sweepers; Pumps (under 4 inch discharge); Signalperson; Survey Rodmen or Chairmen; Tire Repairmen; VAC/ALLS.

Master Mechanic - Master Mechanic

Cranes and Mobile Concrete Pumps 150' -179' - Boom & Jib 150 - 179 feet

Cranes and Mobile Concrete Pumps 180' - 249' - Boom & Jib 180 - 249 feet

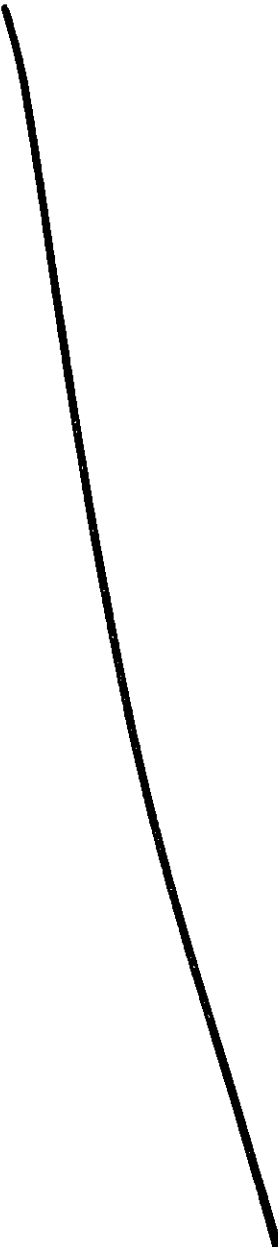

Prevailing Wage Rate Skilled Crafts

Name of Union: Painter Locals 123 & 238

Change # : LCN02-2023ibLoc123-238

Craft : Drywall Finisher Effective Date : 11/15/2023 Last Posted : 11/15/2023

	BHR		Fringe Benefit Payments					Irrevocable Fund		Total PWR	Overtime Rate	
			H&W	Pension	App Tr.	Vac.	Annuity	Other	LECET (*)			MISC (*)
Classification												
Painter Drywall Finisher	\$27.54		\$6.50	\$6.45	\$0.31	\$0.00	\$0.00	\$0.00	\$0.00	\$0.00	\$40.80	\$54.57
Tapers and Finishers	\$27.54		\$6.50	\$6.45	\$0.31	\$0.00	\$0.00	\$0.00	\$0.00	\$0.00	\$40.80	\$54.57
r												
Apprentice	Percent											
1st Year	65.00	\$17.90	\$6.50	\$2.30	\$0.31	\$0.00	\$0.00	\$0.00	\$0.00	\$0.00	\$27.01	\$35.96
2nd Year	70.00	\$19.28	\$6.50	\$2.30	\$0.31	\$0.00	\$0.00	\$0.00	\$0.00	\$0.00	\$28.39	\$38.03
3rd Year	80.00	\$22.03	\$6.50	\$2.30	\$0.31	\$0.00	\$0.00	\$0.00	\$0.00	\$0.00	\$31.14	\$42.16
4th Yea	90.00	\$24.79	\$6.50	\$2.30	\$0.31	\$0.00	\$0.00	\$0.00	\$0.00	\$0.00	\$33.90	\$46.29

Special Calculation Note : Apprentices shall be paid the proper % of the classification above.

Ratio :

1 Journeyman to 1 Apprentice per job

Jurisdiction (* denotes special jurisdictional note) :

BROWN, BUTLER, CLERMONT, CLINTON, HAMILTON, WARREN

Special Jurisdictional Note :

Details :

Industrial Work paid as commercial work above for each class which includes, Industrial Plants, repair garages, processing plants, storage tanks, warehouses, skeletons structures, bridges unless highest point of clearance is 60 feet or more whether new or old construction offices and office buildings in industrial sites are at industrial rates. Heavy & Highway Bridges-Guard Rails- Light Poles. A hazardous steeplejack rate shall apply on radio towers, stacks, light towers, water towers, steeples, skeleton steel, and exterior industrial conveyors over 25 feet, where such items require steeplejack methods and the rate of pay shall be a \$1.00 per hour above the industrial rate. Steeplejack rate to apply to bridges where highest point of clearance is 60 feet.

industrial rate. Steeplejack rate to apply to bridges where highest point of clearance is 60 feet.

Prevailing Wage Rate

Skilled Crafts

Name of Union: Painter Locals 123 & 238
Commercial & Industrial

Change # : LCN01-2024ibLoc123ComInd

Craft : Painter Effective Date : 05/01/2024 Last Posted : 05/01/2024

	BHR		Fringe Benefit Payments					Irrevocable Fund		Total PWR	Overtime Rate	
			H&W	Pension	App Tr.	Vac.	Annuity	Other	LECET (*)			MISC (*)
Classification												
Painter Brush Roll	\$28.29		\$6.50	\$7.20	\$0.31	\$0.00	\$0.00	\$0.00	\$0.00	\$0.00	\$42.30	\$56.45
Paper Hanger	\$28.29		\$6.50	\$7.20	\$0.31	\$0.00	\$0.00	\$0.00	\$0.00	\$0.00	\$42.30	\$56.45
Spray Painter	\$28.79		\$6.50	\$7.20	\$0.31	\$0.00	\$0.00	\$0.00	\$0.00	\$0.00	\$42.80	\$57.20
Sand Blaster Water Blaster	\$29.04		\$6.50	\$7.20	\$0.31	\$0.00	\$0.00	\$0.00	\$0.00	\$0.00	\$43.05	\$57.57
Elevated Tanks	\$29.29		\$6.50	\$7.20	\$0.31	\$0.00	\$0.00	\$0.00	\$0.00	\$0.00	\$43.30	\$57.95
Apprentice	Percent											
1st Year	65.00	\$18.39	\$6.50	\$2.30	\$0.31	\$0.00	\$0.00	\$0.00	\$0.00	\$0.00	\$27.50	\$36.69
2nd Year	70.00	\$19.80	\$6.50	\$2.30	\$0.31	\$0.00	\$0.00	\$0.00	\$0.00	\$0.00	\$28.91	\$38.81
3rd Year	80.00	\$22.63	\$6.50	\$2.30	\$0.31	\$0.00	\$0.00	\$0.00	\$0.00	\$0.00	\$31.74	\$43.06
4th Year	90.00	\$25.46	\$6.50	\$2.30	\$0.31	\$0.00	\$0.00	\$0.00	\$0.00	\$0.00	\$34.57	\$47.30

Special Calculation Note : Apprentices shall be paid the proper % of the classification above.

Ratio :

(1) Journeymen to (1) Apprentice per jobsite

Jurisdiction (* denotes special jurisdictional note) :

BROWN, BUTLER, CLERMONT, CLINTON, HAMILTON, WARREN

Special Jurisdictional Note :

Details :

Industrial Work paid as commercial work above for each class which includes, Industrial Plants, repair garages, processing plants, storage tanks, warehouses, skeletons structures, bridges unless highest point of clearance is 60 feet or more whether new or old construction offices and office buildings in industrial sites are at industrial rates. Heavy & Highway Bridges-GuardRails- Light Poles. A hazardous steeplejack rate shall apply on radio towers, stacks, light towers, water towers, steeples, skeleton steel, and exterior industrial conveyors over 25 feet, where such items require steeplejack methods and the rate of pay shall be a \$1.00 per hour above the industrial rate. Steeplejack rate to apply to bridges where highest point of clearance is 60 feet.

Prevailing Wage Rate

Skilled Crafts

Name of Union: Painter Local 123 & 238 Hvy Hwy

Change # : LCN01-2024ibLoc123

Craft : Painter Effective Date : 05/01/2024 Last Posted : 05/01/2024

	BHR		Fringe Benefit Payments					Irrevocable Fund		Total PWR	Overtime Rate	
			H&W	Pension	App Tr.	Vac.	Annulity	Other	LECET (*)			MISC (*)
Classification												
Painter Bridge Class 1	\$38.68		\$6.50	\$7.20	\$0.31	\$0.00	\$0.00	\$0.00	\$0.00	\$0.00	\$52.69	\$72.03
Bridge Painter, Rigger, Containment Builder, Spot Blaster Class 2	\$31.68		\$6.50	\$7.20	\$0.31	\$0.00	\$0.00	\$0.00	\$0.00	\$0.00	\$45.69	\$61.53
Equipment Operator/Field Mechanic, Grit Reclamation, Paint Mixer, Traffic Control, Boat Person Class 3	\$31.68		\$6.50	\$7.20	\$0.31	\$0.00	\$0.00	\$0.00	\$0.00	\$0.00	\$45.69	\$61.53
Concrete Sealing, Concrete Blasting/Power Washing, Etc. Class 4	\$31.68		\$6.50	\$7.20	\$0.31	\$0.00	\$0.00	\$0.00	\$0.00	\$0.00	\$45.69	\$61.53
Quality Control/Quality Assurance, Traffic Safety, Competent Person Class 5	\$31.68		\$6.50	\$7.20	\$0.31	\$0.00	\$0.00	\$0.00	\$0.00	\$0.00	\$45.69	\$61.53
Apprentice	Percent											
1st Year	65.00	\$25.14	\$2.30	\$6.50	\$0.31	\$0.00	\$0.00	\$0.00	\$0.00	\$0.00	\$34.25	\$46.82
2nd Year	70.00	\$27.08	\$2.30	\$6.50	\$0.31	\$0.00	\$0.00	\$0.00	\$0.00	\$0.00	\$36.19	\$49.72
3rd Year	80.00	\$30.94	\$2.30	\$6.50	\$0.31	\$0.00	\$0.00	\$0.00	\$0.00	\$0.00	\$40.05	\$55.53
4th Year	90.00	\$34.81	\$2.30	\$6.50	\$0.31	\$0.00	\$0.00	\$0.00	\$0.00	\$0.00	\$43.92	\$61.33

Special Calculation Note : Apprentices shall be paid proper % of the classification above..

Ratio :
1 Journeyman to 1 Apprentice

Jurisdiction (* denotes special jurisdictional note) :
BROWN, BUTLER, CLERMONT, CLINTON, HAMILTON, WARREN

Special Jurisdictional Note :

Details :
Industrial Work paid as commercial work above for each class which includes, Industrial Plants, repair garages, processing plants, storage tanks, warehouses, skeletons structures, bridges unless highest point of clearance is 60 feet or more whether new or old construction offices and office buildings in industrial sites are at industrial rates. Heavy & Highway Bridges-Guard Rails- Light Poles. A hazardous steeplejack rate shall apply on radio towers, stacks, light towers, water towers, steeples, skeleton steel, and exterior industrial conveyors over 25 feet, where such items require steeplejack methods and the rate of pay shall be a \$1.00 per hour above the industrial rate. Steeplejack rate to apply to bridges where highest point of clearance is 60 feet.

Class 1 – Abrasive blasting of any kind.

Class 2 – Bridge painting, coating application of any kind. All steel surface preparation other than abrasive blasting. All necessary rigging and containment building. All remedial/ spot blasting.

Class 3 – Tend to all equipment including but not limited to abrasive blasting, power washing, spray painting, forklifts, hoists, trucks, etc. Load and unload trucks, handle materials, man safety boats, handle traffic control, clean up/ vacuum abrasive blast materials and related tasks.

Class 4 – All aspects of concrete coating/ sealing including but not limited to preparation, containment, etc.

Class 5 – Verify and record that all work is completed according to job specifications. Assure that all health and safety standards are adhered to. Assure all traffic is safely handled.

Prevailing Wage Rate Skilled Crafts

Name of Union: Painter Local 639 Zone 2 Sign

Change # : LCN01-2023ibLoc639

Craft : Painter Effective Date : 03/22/2023 Last Posted : 03/22/2023

	BHR	Fringe Benefit Payments						Irrevocable Fund		Total PWR	Overtime Rate
		H&W	Pension	App Tr.	Vac.	Annuity	Other	LECET (*)	MISC (*)		
Classification											
Painter Sign Journeyman Tech/Team Leader Class A	\$25.28	\$1.70	\$0.21	\$0.00	\$0.00	\$0.00	\$0.68	\$0.00	\$0.00	\$27.87	\$40.51
Painter Sign Journeyman Tech/Team Leader Class B	\$25.28	\$1.70	\$0.21	\$0.00	\$0.49	\$0.00	\$0.68	\$0.00	\$0.00	\$28.36	\$41.00
Painter Sign Journeyman Tech/Team Leader Class C	\$25.28	\$1.70	\$0.21	\$0.00	\$0.97	\$0.00	\$0.68	\$0.00	\$0.00	\$28.84	\$41.48
Painter Sign Journeyman Tech/Team Leader Class D	\$25.28	\$1.70	\$0.21	\$0.00	\$1.46	\$0.00	\$0.68	\$0.00	\$0.00	\$29.33	\$41.97
Sign Journeyman Class A	\$25.00	\$1.70	\$0.21	\$0.00	\$0.00	\$0.00	\$0.67	\$0.00	\$0.00	\$27.58	\$40.08
Sign Journeyman Class B	\$25.00	\$1.70	\$0.21	\$0.00	\$0.48	\$0.00	\$0.67	\$0.00	\$0.00	\$28.06	\$40.56
Sign Journeyman Class C	\$25.00	\$1.70	\$0.21	\$0.00	\$0.96	\$0.00	\$0.67	\$0.00	\$0.00	\$28.54	\$41.04
Sign Journeyman Class D	\$25.00	\$1.70	\$0.21	\$0.00	\$1.44	\$0.00	\$0.67	\$0.00	\$0.00	\$29.02	\$41.52
Tech Sign Fabrication/ Erector Class A	\$19.67	\$1.70	\$0.21	\$0.00	\$0.00	\$0.00	\$0.53	\$0.00	\$0.00	\$22.11	\$31.95

Tech Sign Fabrication/ Erector Class B	\$19.67	\$1.70	\$0.21	\$0.00	\$0.38	\$0.00	\$0.53	\$0.00	\$0.00	\$22.49	\$32.33
Tech Sign Fabrication/ Erector Class C	\$19.67	\$1.70	\$0.21	\$0.00	\$0.76	\$0.00	\$0.53	\$0.00	\$0.00	\$22.87	\$32.71
Tech Sign Fabrication/ Erector Class D	\$19.67	\$1.70	\$0.21	\$0.00	\$1.13	\$0.00	\$0.53	\$0.00	\$0.00	\$23.24	\$33.08

Special Calculation Note : Other is for paid holidays.

Ratio :

Jurisdiction (* denotes special jurisdictional note) :

ADAMS, ALLEN, AUGLAIZE, BROWN, BUTLER, CARROLL, CHAMPAIGN, CLARK, CLERMONT, CLINTON, COLUMBIANA, COSHOCTON, CRAWFORD, DARKE, DEFIANCE, DELAWARE, ERIE, FAIRFIELD, FAYETTE, FRANKLIN, FULTON, GREENE, HAMILTON, HANCOCK, HARDIN, HENRY, HIGHLAND, HOLMES, HURON, JACKSON, KNOX, LICKING, LOGAN, LORAIN, LUCAS, MADISON, MAHONING, MARION, MERCER, MIAMI, MONTGOMERY, MORROW, MUSKINGUM, OTTAWA, PAULDING, PERRY, PICKAWAY, PIKE, PREBLE, PUTNAM, ROSS, SANDUSKY, SCIOTO, SENECA, SHELBY, STARK, TRUMBULL, TUSCARAWAS, UNION, VAN WERT, WARREN, WAYNE, WILLIAMS, WOOD, WYANDOT

Special Jurisdictional Note :

Details :

Class A: less that 1 year.

Class B: 1-3 years.

Class C; 3-10 years.

Class D: More than 10 years.

Prevailing Wage Rate Skilled Crafts

Name of Union: Painter Local 639

Change # : LCNO1-2015fbLoc639

Craft : Painter Effective Date : 06/10/2015 Last Posted : 06/10/2015

	BHR	Fringe Benefit Payments						Irrevocable Fund		Total PWR	Overtime Rate
		H&W	Pension	App Tr.	Vac.	Annuity	Other	LECET (*)	MISC (*)		
Classification											
Painter Metal Finisher/Helpers											
Top Helper Class A	\$19.09	\$3.65	\$0.00	\$0.00	\$0.66	\$0.00	\$0.00	\$0.00	\$0.00	\$23.40	\$32.94
Top Helper Class B	\$19.09	\$3.65	\$0.65	\$0.00	\$1.03	\$0.00	\$0.37	\$0.00	\$0.00	\$24.79	\$34.33
Top Helper Class C	\$19.09	\$3.65	\$1.00	\$0.00	\$1.76	\$0.00	\$0.37	\$0.00	\$0.00	\$25.87	\$35.41
Helper Class A	\$14.69	\$3.65	\$0.00	\$0.00	\$0.51	\$0.00	\$0.00	\$0.00	\$0.00	\$18.85	\$26.19
Helper Class B	\$14.69	\$3.65	\$0.65	\$0.00	\$0.79	\$0.00	\$0.28	\$0.00	\$0.00	\$20.06	\$27.40
Helper Class C	\$14.69	\$3.65	\$1.00	\$0.00	\$1.64	\$0.00	\$0.28	\$0.00	\$0.00	\$21.26	\$28.60
New Hire 90 Days	\$11.00	\$3.65	\$0.00	\$0.00	\$0.00	\$0.00	\$0.00	\$0.00	\$0.00	\$14.65	\$20.15

Special Calculation Note : Other is Sick and Personal Time

Ratio :

Jurisdiction (* denotes special jurisdictional note) :

ADAMS, ALLEN, ASHLAND, ASHTABULA, ATHENS, AUGLAIZE, BELMONT, BROWN, BUTLER, CARROLL, CHAMPAIGN, CLARK, CLERMONT, CLINTON, COLUMBIANA, COSHOCTON, CRAWFORD, CUYAHOGA, DARKE, DEFIANCE, DELAWARE, ERIE, FAIRFIELD, FAYETTE, FRANKLIN, FULTON, GALLIA, GEauga, GREENE, GUERNSEY, HAMILTON, HANCOCK, HARDIN, HARRISON, HENRY, HIGHLAND, HOCKING, HOLMES, HURON, JACKSON, JEFFERSON, KNOX, LAKE, LAWRENCE, LICKING, LOGAN, LORAIN, LUCAS, MADISON, MAHONING, MARION, MEDINA, MEIGS, MERCER, MIAMI, MONROE, MONTGOMERY, MORGAN, MORROW, MUSKINGUM, NOBLE, OTTAWA, PAULDING, PERRY, PICKAWAY, PIKE, PORTAGE, PREBLE, PUTNAM, RICHLAND, ROSS, SANDUSKY,

SCIOTO, SENECA, SHELBY, STARK, SUMMIT,
TRUMBULL, TUSCARAWAS, UNION, VAN
WERT, VINTON, WARREN, WASHINGTON,
WAYNE, WILLIAMS, WOOD, WYANDOT

Special Jurisdictional Note :

Details :

Top Helper: Shall perform the responsibilities of a Helper and be responsible for the setup, break down, safety and quality of the company's product.

Helper : Shall be responsible for performing tasks in refinishing, compliance with safety procedures, setting up and breaking down job sites, scaffolding and swing stages and preparing surfaces for refinishing including but not limited to, masking and stripping and cleaning, oxidizing, polishing and scratch removal on various surfaces

Class A Workers: Less than 1 Year of Service.

Class B Workers: More than 1 and less than 8 Years of Service.

Class C Workers: More than 8 Years of Service.

Metal Polisher Scope of Work: Polishing, buffing, stripping, coloring, lacquering, spraying, cleaning and maintenance of ornamental and architectural metals, iron, bronze, nickel, aluminum and stainless steel and in mental specialty work, various stone finishes, stone specialty work and any other work pertaining to the finishing of metal, stones, woods, and any window washing/cleaning done in conjunction with this work, using chemicals, solvents, coatings and hand applied lacquer thinner, removing scratches from mirror finished metals, burnishing of bronze, statuary finishes on exterior and interior surfaces and the use of all tools required to perform such work, including but not limited to polishes, spray equipment and scaffolding.

Swing State Rate: All work on scaffold 4 sections or higher, including any boom lifts and swing stage scaffolds including the rigging and derigging of hanging/suspended swing stage systems and rappelling/bolson chair work, ADD \$1.50 per hour.

Prevailing Wage Rate Skilled Crafts

Name of Union: Painter Local 639 Zone 2 Sign

Change # : LCN01-2016fbLoc639

Craft : Painter Effective Date : 08/03/2016 Last Posted : 08/03/2016

	BHR	Fringe Benefit Payments						Irrevocable Fund		Total PWR	Overtime Rate
		H&W	Pension	App Tr.	Vac.	Annuity	Other	LECET (*)	MISC (*)		
Classification											
Painter Sign Journeyman Tech/Team Leader Class A	\$21.25	\$1.33	\$0.14	\$0.00	\$0.00	\$0.00	\$0.57	\$0.00	\$0.00	\$23.29	\$33.92
Painter Sign Journeyman Tech/Team Leader Class B	\$21.25	\$1.33	\$0.14	\$0.00	\$0.41	\$0.00	\$0.57	\$0.00	\$0.00	\$23.70	\$34.32
Painter Sign Journeyman Tech/Team Leader Class C	\$21.25	\$1.33	\$0.14	\$0.00	\$0.82	\$0.00	\$0.57	\$0.00	\$0.00	\$24.11	\$34.74
Painter Sign Journeyman Tech/Team Leader Class D	\$21.25	\$1.33	\$0.14	\$0.00	\$1.23	\$0.00	\$0.57	\$0.00	\$0.00	\$24.52	\$35.14
Sign Journeyman Class A	\$20.98	\$1.33	\$0.14	\$0.00	\$0.00	\$0.00	\$0.56	\$0.00	\$0.00	\$23.01	\$33.50
Sign Journeyman Class B	\$20.98	\$1.33	\$0.14	\$0.00	\$0.40	\$0.00	\$0.56	\$0.00	\$0.00	\$23.41	\$33.90
Sign Journeyman Class C	\$20.98	\$1.33	\$0.14	\$0.00	\$0.81	\$0.00	\$0.56	\$0.00	\$0.00	\$23.82	\$34.31
Sign Journeyman Class D	\$20.98	\$1.33	\$0.14	\$0.00	\$1.21	\$0.00	\$0.56	\$0.00	\$0.00	\$24.22	\$34.71
Tech Sign Fabrication/Erector Class A	\$15.90	\$1.33	\$0.14	\$0.00	\$0.00	\$0.00	\$0.43	\$0.00	\$0.00	\$17.80	\$25.75
Tech Sign Fabrication/Erector Class B	\$15.90	\$1.33	\$0.14	\$0.00	\$0.31	\$0.00	\$0.43	\$0.00	\$0.00	\$18.11	\$26.06
Tech Sign Fabrication/Erector Class C	\$15.90	\$1.33	\$0.14	\$0.00	\$0.61	\$0.00	\$0.43	\$0.00	\$0.00	\$18.41	\$26.36
Tech Sign Fabrication/Erector Class D	\$15.90	\$1.33	\$0.14	\$0.00	\$0.92	\$0.00	\$0.43	\$0.00	\$0.00	\$18.72	\$26.67

Special Calculation Note : Other is for paid holidays.

Ratio :

Jurisdiction (* denotes special jurisdictional note) :

ADAMS, ALLEN, AUGLAIZE, BROWN, BUTLER,
CARROLL, CHAMPAIGN, CLARK, CLERMONT, CLINTON,
COLUMBIANA, COSHOCTON, CRAWFORD, DARKE,
DEFIANCE, DELAWARE, ERIE, FAIRFIELD, FAYETTE,
FRANKLIN, FULTON, GREENE, HAMILTON, HANCOCK,
HARDIN, HENRY, HIGHLAND, HOLMES, HURON,
JACKSON, KNOX, LICKING, LOGAN, LORAIN, LUCAS,
MADISON, MAHONING, MARION, MERCER, MIAMI,
MONTGOMERY, MORROW, MUSKINGUM, OTTAWA,
PAULDING, PERRY, PICKAWAY, PIKE, PREBLE,
PUTNAM, ROSS, SANDUSKY, SCIOTO, SENECA,
SHELBY, STARK, TRUMBULL, TUSCARAWAS, UNION,
VAN WERT, WARREN, WAYNE, WILLIAMS, WOOD,
WYANDOT

Special Jurisdictional Note :

Details :

Class A: less than 1 year.

Class B: 1-3 years.

Class C: 3-10 years.

Class D: More than 10 years.

Prevailing Wage Rate Skilled Crafts

Name of Union: Plasterer Local 132 (Cincinnati)

Change # : LCN01-2024ibLoc132Cinci

Craft : Plasterer Effective Date : 07/01/2024 Last Posted : 06/26/2024

	BHR		Fringe Benefit Payments					Irrevocable Fund		Total PWR	Overtime Rate	
			II&W	Pension	App Tr.	Vac.	Annuity	Other	LECET (*)			MISC (*)
Classification												
Plasterer	\$30.40		\$6.10	\$8.47	\$0.70	\$0.00	\$1.00	\$0.06	\$0.00	\$0.00	\$46.73	\$61.93
Apprentice	Percent											
1st 900 hours	70.00	\$21.28	\$6.10	\$0.00	\$0.70	\$0.00	\$1.00	\$0.06	\$0.00	\$0.00	\$29.14	\$39.78
2nd 900 hours	74.00	\$22.50	\$6.10	\$0.00	\$0.70	\$0.00	\$1.00	\$0.06	\$0.00	\$0.00	\$30.36	\$41.60
3rd 900 hours	78.00	\$23.71	\$6.10	\$7.74	\$0.70	\$0.00	\$1.00	\$0.06	\$0.00	\$0.00	\$39.31	\$51.17
4th 900 hours	82.00	\$24.93	\$6.10	\$7.74	\$0.70	\$0.00	\$1.00	\$0.06	\$0.00	\$0.00	\$40.53	\$52.99
5th 900 hours	86.00	\$26.14	\$6.10	\$7.74	\$0.70	\$0.00	\$1.00	\$0.06	\$0.00	\$0.00	\$41.74	\$54.82
6th 900 hours	90.00	\$27.36	\$6.10	\$7.74	\$0.70	\$0.00	\$1.00	\$0.06	\$0.00	\$0.00	\$42.96	\$56.64
7th 900 hours	94.00	\$28.58	\$6.10	\$7.74	\$0.70	\$0.00	\$1.00	\$0.06	\$0.00	\$0.00	\$44.18	\$58.46
8th 900 hours	98.00	\$29.79	\$6.10	\$7.74	\$0.70	\$0.00	\$1.00	\$0.06	\$0.00	\$0.00	\$45.39	\$60.29

Special Calculation Note : No special calculations for this skilled craft wage rate are required at this time.

*Other is International Training

Ratio :

- 1 Journeyman to 1 Apprentice
- 4 Journeyman to 2 Apprentice
- 7 Journeyman to 3 Apprentice

Jurisdiction (* denotes special jurisdictional note) :
BROWN, BUTLER, CLERMONT, HAMILTON, HIGHLAND, WARREN

Special Jurisdictional Note :

Details :

Apprentice and Shop Hand Pension are \$1.00 less than Journeyman.

Prevailing Wage Rate Skilled Crafts

Name of Union: Plumber Pipefitter Local 392

Change # : LCN01-2024ibLoc392

Craft : Plumber/Pipefitter Effective Date : 06/01/2024 Last Posted : 05/29/2024

	BHR		Fringe Benefit Payments					Irrevocable Fund		Total PWR	Overtime Rate	
			H&W	Pension	App Tr.	Vac.	Annuity	Other	LECET (*)			MISC (*)
Classification												
Plumber Pipefitter	\$40.70		\$11.08	\$14.15	\$0.89	\$0.00	\$0.00	\$0.63	\$0.00	\$0.00	\$67.45	\$87.80
Plumber Helper	\$26.46		\$10.98	\$7.40	\$0.89	\$0.00	\$0.00	\$0.00	\$0.00	\$0.00	\$45.73	\$58.96
Apprentice	Percent											
1st Year	52.00	\$21.16	\$10.88	\$1.15	\$0.89	\$0.00	\$0.00	\$0.63	\$0.00	\$0.00	\$34.71	\$45.30
2nd Year	55.00	\$22.39	\$10.88	\$1.15	\$0.89	\$0.00	\$0.00	\$0.63	\$0.00	\$0.00	\$35.94	\$47.13
3rd Year	58.00	\$23.61	\$10.88	\$7.90	\$0.89	\$0.00	\$0.00	\$0.63	\$0.00	\$0.00	\$43.91	\$55.71
4th Year	62.00	\$25.23	\$10.88	\$7.90	\$0.89	\$0.00	\$0.00	\$0.63	\$0.00	\$0.00	\$45.53	\$58.15
5th Year	75.00	\$30.53	\$10.88	\$14.15	\$0.89	\$0.00	\$0.00	\$0.63	\$0.00	\$0.00	\$57.08	\$72.34

Special Calculation Note : OTHER IS: SUPPLEMENTAL UNEMPLOYMENT BENEFITS.

Ratio :

- 1 Journeymen to 1 Apprentice
- 2 Journeymen to 4 Apprentices
- 3 Journeymen to 6 Apprentices

Jurisdiction (* denotes special jurisdictional note) :

BROWN, BUTLER, CLERMONT, HAMILTON, WARREN

When more than Sixteen (16) Journeymen are employed additional apprentices may be acquired at a ratio of one (1) apprentice to four (4) journeymen.

Special Jurisdictional Note :

Details :

Helpers shall be permitted to work on ONLY , Exterior Sewers, Concrete, Vitrified Clay or PVC Pipe and Digging and Backfilling for Piping Work. The ratio shall not exceed 2 helpers to 1 Journeymen when performing the scope of work listed above

Prevailing Wage Rate Skilled Crafts

Name of Union: Roofer Local 42

Change # : LCN01-2024ibLoc42

Craft : Roofer Effective Date : 01/24/2024 Last Posted : 01/24/2024

	BHR		Fringe Benefit Payments					Irrevocable Fund		Total PWR	Overtime Rate	
			H&W	Pension	App Tr.	Vac.	Annuity	Other	LECET (*)			MISC (*)
Classification												
Roofer	\$32.00		\$8.40	\$8.57	\$0.50	\$0.00	\$1.47	\$0.21	\$0.00	\$0.00	\$51.15	\$67.15
Tradesmen	\$25.60		\$8.40	\$6.85	\$0.00	\$0.00	\$1.47	\$0.06	\$0.00	\$0.00	\$42.38	\$55.18
Apprentice	Percent											
1st period	65.00	\$20.80	\$8.40	\$5.57	\$0.00	\$0.00	\$1.47	\$0.00	\$0.00	\$0.00	\$36.24	\$46.64
2nd period	70.00	\$22.40	\$8.40	\$6.00	\$0.00	\$0.00	\$1.47	\$0.00	\$0.00	\$0.00	\$38.27	\$49.47
3rd period	80.00	\$25.60	\$8.40	\$6.85	\$0.00	\$0.00	\$1.47	\$0.00	\$0.00	\$0.00	\$42.32	\$55.12

Special Calculation Note : Other is for Training Fund

Ratio :

Employer may employ 1 apprentice for every 2 journeymen in his employment.

Jurisdiction (* denotes special jurisdictional note) :

ADAMS, BROWN, BUTLER, CLERMONT, HAMILTON, PIKE, WARREN

Special Jurisdictional Note :

Details :

Any Tradesman Worker completing 2,000 hours in (2) years may move to Journeyman status by utilizing the Training Yard to improve their skills. Tradesman Workers will be tested at these yards to determine their competency for Journeyman status. Tradesman Workers must schedule and successfully complete the industry test battery in order to gain journeyman status.

Prevailing Wage Rate Skilled Crafts

Name of Union: Sheet Metal Local 24 (Dayton)

Change # : LCN01-2023ibLoc24(Day)

Craft : Sheet Metal Worker Effective Date : 06/07/2023 Last Posted : 06/07/2023

	BHR		Fringe Benefit Payments					Irrevocable Fund		Total PWR	Overtime Rate	
			H&W	Pension	App Tr.	Vac.	Annuity	Other	LECET (*)			MISC (*)
Classification												
Sheet Metal Worker	\$31.23		\$9.64	\$15.10	\$1.05	\$0.00	\$0.00	\$0.00	\$0.00	\$0.00	\$57.02	\$72.63
Apprentice	Percent											
Apprentice												
5th Year B	85.00	\$26.55	\$9.40	\$11.47	\$1.05	\$0.00	\$0.00	\$0.00	\$0.00	\$0.00	\$48.47	\$61.74
5th Year A	80.00	\$24.98	\$9.31	\$10.28	\$1.05	\$0.00	\$0.00	\$0.00	\$0.00	\$0.00	\$45.62	\$58.12
4th Year B	75.00	\$23.42	\$9.23	\$9.07	\$1.05	\$0.00	\$0.00	\$0.00	\$0.00	\$0.00	\$42.77	\$54.48
4th Year A	70.00	\$21.86	\$9.15	\$7.85	\$1.05	\$0.00	\$0.00	\$0.00	\$0.00	\$0.00	\$39.91	\$50.84
3rd year B	65.00	\$20.30	\$9.06	\$6.65	\$1.05	\$0.00	\$0.00	\$0.00	\$0.00	\$0.00	\$37.06	\$47.21
3rd Year A	60.00	\$18.74	\$8.98	\$5.44	\$1.05	\$0.00	\$0.00	\$0.00	\$0.00	\$0.00	\$34.21	\$43.58
2 Year B	57.52	\$17.96	\$8.94	\$4.84	\$1.05	\$0.00	\$0.00	\$0.00	\$0.00	\$0.00	\$32.79	\$41.78
2 Year A	55.00	\$17.18	\$8.90	\$4.23	\$1.05	\$0.00	\$0.00	\$0.00	\$0.00	\$0.00	\$31.36	\$39.94
Probationary 1 Year	52.50	\$16.40	\$8.86	\$3.63	\$1.05	\$0.00	\$0.00	\$0.00	\$0.00	\$0.00	\$29.94	\$38.13

Special Calculation Note : No special calculations for this skilled craft wage rate are required at this time.

Ratio :

1 Journeyman to 1 Apprentice then,
1 Apprentice for every 2 Journeymen thereafter

Jurisdiction (* denotes special jurisdictional note) :

ALLEN, AUGLAIZE, BUTLER, CHAMPAIGN,
CLARK, CLINTON, DARKE, GREENE, HARDIN,
LOGAN, MERCER, MIAMI, MONTGOMERY,
PREBLE, SHELBY, VAN WERT, WARREN,
WYANDOT

Special Jurisdictional Note :

Details :

Prevailing Wage Rate Skilled Crafts

Name of Union: Sprinkler Fitter Local 669

Change # : LCN01-2022sksLoc669

Craft : Sprinkler Fitter Effective Date : 04/06/2022 Last Posted : 04/06/2022

	BHR		Fringe Benefit Payments					Irrevocable Fund		Total PWR	Overtime Rate	
			H&W	Pension	App Tr.	Vac.	Annuity	Other	LECET (*)			MISC (*)
Classification												
Sprinkler Fitter	\$43.75		\$10.99	\$7.10	\$0.52	\$0.00	\$5.12	\$0.00	\$0.00	\$0.00	\$67.48	\$89.35
Apprentice Indentured after April 1, 2013	Percent											
CLASS 1	45.00	\$19.69	\$7.85	\$0.00	\$0.52	\$0.00	\$0.00	\$0.00	\$0.00	\$0.00	\$28.06	\$37.90
CLASS 2	50.02	\$21.88	\$7.85	\$0.00	\$0.52	\$0.00	\$0.00	\$0.00	\$0.00	\$0.00	\$30.25	\$41.20
CLASS 3	54.43	\$23.81	\$10.99	\$7.10	\$0.52	\$0.00	\$1.15	\$0.00	\$0.00	\$0.00	\$43.57	\$55.48
CLASS 4	59.43	\$26.00	\$10.99	\$7.10	\$0.52	\$0.00	\$1.15	\$0.00	\$0.00	\$0.00	\$45.76	\$58.76
CLASS 5	64.43	\$28.19	\$10.99	\$7.10	\$0.52	\$0.00	\$1.40	\$0.00	\$0.00	\$0.00	\$48.20	\$62.29
CLASS 6	69.43	\$30.38	\$10.99	\$7.10	\$0.52	\$0.00	\$1.40	\$0.00	\$0.00	\$0.00	\$50.39	\$65.57
CLASS 7	74.43	\$32.56	\$10.99	\$7.10	\$0.52	\$0.00	\$1.40	\$0.00	\$0.00	\$0.00	\$52.57	\$68.85
CLASS 8	79.42	\$34.75	\$10.99	\$7.10	\$0.52	\$0.00	\$1.40	\$0.00	\$0.00	\$0.00	\$54.76	\$72.13
CLASS 9	84.43	\$36.94	\$10.99	\$7.10	\$0.52	\$0.00	\$1.40	\$0.00	\$0.00	\$0.00	\$56.95	\$75.42
CLASS 10	89.44	\$39.13	\$10.99	\$7.10	\$0.52	\$0.00	\$1.40	\$0.00	\$0.00	\$0.00	\$59.14	\$78.70

Special Calculation Note :

Ratio :

1 Journeyman to 1 Apprentice

Jurisdiction (* denotes special jurisdictional note) :

ADAMS, ALLEN, ASHLAND, ASHTABULA, ATHENS, AUGLAIZE, BELMONT, BROWN, BUTLER, CARROLL, CHAMPAIGN, CLARK, CLERMONT, CLINTON, COLUMBIANA, COSHOCTON, CRAWFORD, DARKE, DEFIANCE, DELAWARE, ERIE, FAIRFIELD, FAYETTE, FRANKLIN, FULTON, GALLIA, GREENE, GUERNSEY, HAMILTON, HANCOCK, HARDIN, HARRISON, HENRY, HIGHLAND, HOCKING, HOLMES, HURON, JACKSON, JEFFERSON, KNOX, LAWRENCE, LICKING, LOGAN, LUCAS, MADISON, MAHONING, MARION, MEDINA, MEIGS, MERCER, MIAMI, MONROE, MONTGOMERY, MORGAN, MORROW,

MUSKINGUM, NOBLE, OTTAWA, PAULDING,
PERRY, PICKAWAY, PIKE, PORTAGE, PREBLE,
PUTNAM, RICHLAND, ROSS, SANDUSKY,
SCIOTO, SENECA, SHELBY, STARK, SUMMIT,
TRUMBULL, TUSCARAWAS, UNION, VAN WERT,
VINTON, WARREN, WASHINGTON, WAYNE,
WILLIAMS, WOOD, WYANDOT

Special Jurisdictional Note :

Details :

Sprinkler Fitter work shall consist of the installation, dismantling, maintenance, repairs, adjustments, and corrections of all fire protection and fire control systems including the unloading, handling by hand, power equipment and installation of all piping or tubing, appurtenances and equipment pertaining thereto, including both overhead and underground water mains, fire hydrants and hydrant mains, standpipes and hose connections to sprinkler systems used in connection with sprinkler and alarm systems. Also all tanks and pumps connected thereto, also included shall be CO-2 and Cardox Systems, Dry Chemical Systems, Foam Systems and all other fire protection systems.

Prevailing Wage Rate Skilled Crafts

Name of Union: Truck Driver Bldg & HevHwy Class 1
Locals 20,40,92,92b,100,175,284,438,377,637,908,957

Change # : LCN01-2024IbBldgHevHwy

Craft : Truck Driver Effective Date : 05/01/2024 Last Posted : 05/01/2024

	BHR		Fringe Benefit Payments					Irrevocable Fund		Total PWR	Overtime Rate	
			H&W	Pension	App Tr.	Vac.	Annuity	Other	LECET (*)			MISC (*)
Classification												
Truck Driver CLASS 1 4 wheel service, dump, and batch trucks; drivers on tandems; truck sweepers (not to include power sweepers & scrubbers)	\$31.84		\$8.00	\$9.60	\$0.40	\$0.00	\$0.00	\$0.00	\$0.00	\$0.00	\$49.84	\$65.76
Apprentice	Percent											
First 6 months	80.00	\$25.47	\$8.00	\$9.60	\$0.40	\$0.00	\$0.00	\$0.00	\$0.00	\$0.00	\$43.47	\$56.21
7-12 months	85.00	\$27.06	\$8.00	\$9.60	\$0.40	\$0.00	\$0.00	\$0.00	\$0.00	\$0.00	\$45.06	\$58.60
13-18 months	90.00	\$28.66	\$8.00	\$9.60	\$0.40	\$0.00	\$0.00	\$0.00	\$0.00	\$0.00	\$46.66	\$60.98
19-24 months	95.00	\$30.25	\$8.00	\$9.60	\$0.40	\$0.00	\$0.00	\$0.00	\$0.00	\$0.00	\$48.25	\$63.37
25-30 months	100.00	\$31.84	\$8.00	\$9.60	\$0.40	\$0.00	\$0.00	\$0.00	\$0.00	\$0.00	\$49.84	\$65.76

Special Calculation Note : No special calculations for this skilled craft wage rate are required at this time.

Ratio :

3 Journeymen to 1 Apprentice

Jurisdiction (* denotes special jurisdictional note) :

ADAMS, ALLEN, ASHLAND, ASHTABULA, ATHENS, AUGLAIZE, BELMONT, BROWN, BUTLER, CARROLL, CHAMPAIGN, CLARK, CLERMONT, CLINTON, COLUMBIANA, COSHOCTON, CRAWFORD, DARKE, DEFIANCE, DELAWARE, ERIE, FAIRFIELD, FAYETTE, FRANKLIN, FULTON, GALLIA, GREENE, GUERNSEY, HAMILTON, HANCOCK, HARDIN, HARRISON, HENRY, HIGHLAND, HOCKING, HOLMES, HURON, JACKSON, JEFFERSON, KNOX, LAWRENCE, LICKING, LOGAN, LORAIN, LUCAS, MADISON, MAHONING, MARION, MEDINA, MEIGS, MERCER, MIAMI, MONROE, MONTGOMERY, MORGAN, MORROW, MUSKINGUM, NOBLE, OTTAWA, PAULDING, PERRY, PICKAWAY, PIKE, PORTAGE, PREBLE, PUTNAM, RICHLAND, ROSS, SANDUSKY, SCIOTO, SENECA, SHELBY, STARK, SUMMIT, TRUMBULL, TUSCARAWAS, UNION, VAN WERT, VINTON, WARREN, WASHINGTON, WAYNE, WILLIAMS, WOOD, WYANDOT

Special Jurisdictional Note :

Details :

Prevailing Wage Rate

Skilled Crafts

Name of Union: Truck Driver Bldg & HevHwy Class 3
 Locals 20,40,92,92b,100,175,284,438,377,637,908,957

Change # : LCN01-2024ibBldgHevHwy3

Craft : Truck Driver Effective Date : 05/01/2024 Last Posted : 05/01/2024

	BHR		Fringe Benefit Payments						Irrevocable Fund		Total PWR	Overtime Rate
			H&W	Pension	App Tr.	Vac.	Annuity	Other	LECET (*)	MISC (*)		
Classification												
Truck Driver CLASS 3 Articulated Dump Trucks; Ridge-Frame Rock Trucks; Distributor Trucks)	\$33.26		\$8.00	\$9.60	\$0.40	\$0.00	\$0.00	\$0.00	\$0.00	\$0.00	\$51.26	\$67.89
Apprentice	Percent											
First 6 months	80.00	\$26.61	\$8.00	\$9.60	\$0.40	\$0.00	\$0.00	\$0.00	\$0.00	\$0.00	\$44.61	\$57.91
7-12 months	85.00	\$28.27	\$8.00	\$9.60	\$0.40	\$0.00	\$0.00	\$0.00	\$0.00	\$0.00	\$46.27	\$60.41
13-18 months	90.00	\$29.93	\$8.00	\$9.60	\$0.40	\$0.00	\$0.00	\$0.00	\$0.00	\$0.00	\$47.93	\$62.90
19-24 months	94.96	\$31.58	\$8.00	\$9.60	\$0.40	\$0.00	\$0.00	\$0.00	\$0.00	\$0.00	\$49.58	\$65.38
25-30 months	100.00	\$33.26	\$8.00	\$9.60	\$0.40	\$0.00	\$0.00	\$0.00	\$0.00	\$0.00	\$51.26	\$67.89

Special Calculation Note : No special calculations for this skilled craft wage rate are required at this time.

Ratio :

3 Journeymen to 1 Apprentice

Jurisdiction (* denotes special jurisdictional note) :

ADAMS, ALLEN, ASHLAND, ASHTABULA, ATHENS, AUGLAIZE, BELMONT, BROWN, BUTLER, CARROLL, CHAMPAIGN, CLARK, CLERMONT, CLINTON, COLUMBIANA, COSHOCTON, CRAWFORD, DARKE, DEFIANCE, DELAWARE, ERIE, FAIRFIELD, FAYETTE, FRANKLIN, FULTON, GALLIA, GREENE, GUERNSEY, HAMILTON, HANCOCK, HARDIN, HARRISON, HENRY, HIGHLAND, HOCKING, HOLMES, HURON, JACKSON, JEFFERSON, KNOX, LAWRENCE, LICKING, LOGAN, LORAIN, LUCAS, MADISON, MAHONING, MARION, MEDINA, MEIGS, MERCER, MIAMI, MONROE, MONTGOMERY, MORGAN, MORROW, MUSKINGUM, NOBLE, OTTAWA, PAULDING, PERRY, PICKAWAY, PIKE, PORTAGE, PREBLE, PUTNAM, RICHLAND, ROSS, SANDUSKY, SCIOTO, SENECA, SHELBY, STARK, SUMMIT, TRUMBULL, TUSCARAWAS, UNION, VAN WERT, VINTON, WARREN, WASHINGTON, WAYNE, WILLIAMS, WOOD, WYANDOT

Special Jurisdictional Note :

Details :

Prevailing Wage Rate Skilled Crafts

Name of Union: Truck Driver Bldg & Hwy Class 2
Locals 20,40,92,92b,100,175,284,438,377,637,908,957

Change # : LCN01-2024ibBldgHwy

Craft : Truck Driver Effective Date : 05/01/2024 Last Posted : 05/01/2024

	BHR		Fringe Benefit Payments						Irrevocable Fund		Total PWR	Overtime Rate
			H&W	Pension	App Tr.	Vac.	Annuity	Other	LECET (*)	MISC (*)		
Classification												
Truck Driver CLASS 2 Tractor Trailer-Semi Tractor Trucks; Pole Trailers; Ready Mix Trucks; Fuel Trucks; 5 Axle & Over; Belly Dumps; Low boys - Heavy duty Equipment(irrespective of load carried) when used exclusively for transportation; Truck Mechanics (when needed)	\$32.26		\$8.00	\$9.60	\$0.40	\$0.00	\$0.00	\$0.00	\$0.00	\$0.00	\$50.26	\$66.39
Apprentice	Percent											
First 6 months	80.00	\$25.81	\$8.00	\$9.60	\$0.40	\$0.00	\$0.00	\$0.00	\$0.00	\$0.00	\$43.81	\$56.71
7-12 months	85.00	\$27.42	\$8.00	\$9.60	\$0.40	\$0.00	\$0.00	\$0.00	\$0.00	\$0.00	\$45.42	\$59.13
13-18 months	90.00	\$29.03	\$8.00	\$9.60	\$0.40	\$0.00	\$0.00	\$0.00	\$0.00	\$0.00	\$47.03	\$61.55
19-24 months	95.00	\$30.65	\$8.00	\$9.60	\$0.40	\$0.00	\$0.00	\$0.00	\$0.00	\$0.00	\$48.65	\$63.97
25-30 months	100.00	\$32.26	\$8.00	\$9.60	\$0.40	\$0.00	\$0.00	\$0.00	\$0.00	\$0.00	\$50.26	\$66.39

Special Calculation Note : No special calculations for this skilled craft wage rate are required at this time.

Ratio :
3 Journeymen to 1 Apprentice

Jurisdiction (* denotes special jurisdictional note) :
ADAMS, ALLEN, ASHLAND, ASHTABULA, ATHENS,
AUGLAIZE, BELMONT, BROWN, BUTLER, CARROLL,
CHAMPAIGN, CLARK, CLERMONT, CLINTON, COLUMBIANA,
COSHOCTON, CRAWFORD, DARKE, DEFIANCE, DELAWARE,
ERIE, FAIRFIELD, FAYETTE, FRANKLIN, FULTON, GALLIA,
GREENE, GUERNSEY, HAMILTON, HANCOCK, HARDIN,
HARRISON, HENRY, HIGHLAND, HOCKING, HOLMES,
HURON, JACKSON, JEFFERSON, KNOX, LAWRENCE,
LICKING, LOGAN, LORAIN, LUCAS, MADISON, MAHONING,
MARION, MEDINA, MEIGS, MERCER, MIAMI, MONROE,
MONTGOMERY, MORGAN, MORROW, MUSKINGUM, NOBLE,
OTTAWA, PAULDING, PERRY, PICKAWAY, PIKE, PORTAGE,
PREBLE, PUTNAM, RICHLAND, ROSS, SANDUSKY, SCIOTO,
SENECA, SHELBY, STARK, SUMMIT, TRUMBULL,
TUSCARAWAS, UNION, VAN WERT, VINTON, WARREN,
WASHINGTON, WAYNE, WILLIAMS, WOOD, WYANDOT

Special Jurisdictional Note :

Details :

Prevailing Wage Rate

Skilled Crafts

Name of Union: Truck Driver Bldg & HevHwy Class 3
Locals 20,40,92,92b,100,175,284,438,377,637,908,957

Change # : LCN01-2023ibBldgHevHwy3

Craft : Truck Driver Effective Date : 05/01/2023 Last Posted : 04/26/2023

	BHR		Fringe Benefit Payments					Irrevocable Fund		Total PWR	Overtime Rate	
			H&W	Pension	App Tr.	Vac.	Annuity	Other	LECET (*)	MISC (*)		
Classification												
Truck Driver CLASS 3 Articulated Dump Trucks; Ridge-Frame Rock Trucks; Distributor Trucks)	\$32.66		\$7.75	\$9.20	\$0.20	\$0.00	\$0.00	\$0.00	\$0.00	\$0.00	\$49.81	\$66.14
Apprentice	Percent											
First 6 months	80.00	\$26.13	\$7.75	\$9.20	\$0.20	\$0.00	\$0.00	\$0.00	\$0.00	\$0.00	\$43.28	\$56.34
7-12 months	85.00	\$27.76	\$7.75	\$9.20	\$0.20	\$0.00	\$0.00	\$0.00	\$0.00	\$0.00	\$44.91	\$58.79
13-18 months	90.00	\$29.39	\$7.75	\$9.20	\$0.20	\$0.00	\$0.00	\$0.00	\$0.00	\$0.00	\$46.54	\$61.24
19-24 months	95.00	\$31.03	\$7.75	\$9.20	\$0.20	\$0.00	\$0.00	\$0.00	\$0.00	\$0.00	\$48.18	\$63.69
25-30 months	100.00	\$32.66	\$7.75	\$9.20	\$0.20	\$0.00	\$0.00	\$0.00	\$0.00	\$0.00	\$49.81	\$66.14

Special Calculation Note : No special calculations for this skilled craft wage rate are required at this time.

Ratio :

3 Journeymen to 1 Apprentice

Jurisdiction (* denotes special jurisdictional note) :

ADAMS, ALLEN, ASHLAND, ASHTABULA, ATHENS, AUGLAIZE, BELMONT, BROWN, BUTLER, CARROLL, CHAMPAIGN, CLARK, CLERMONT, CLINTON, COLUMBIANA, COSHOCTON, CRAWFORD, DARKE, DEFIANCE, DELAWARE, ERIE, FAIRFIELD, FAYETTE, FRANKLIN, FULTON, GALLIA, GREENE,

GUERNSEY, HAMILTON, HANCOCK, HARDIN,
HARRISON, HENRY, HIGHLAND, HOCKING,
HOLMES, HURON, JACKSON, JEFFERSON,
KNOX, LAWRENCE, LICKING, LOGAN, LORAIN,
LUCAS, MADISON, MAHONING, MARION,
MEDINA, MEIGS, MERCER, MIAMI, MONROE,
MONTGOMERY, MORGAN, MORROW,
MUSKINGUM, NOBLE, OTTAWA, PAULDING,
PERRY, PICKAWAY, PIKE, PORTAGE, PREBLE,
PUTNAM, RICHLAND, ROSS, SANDUSKY,
SCIOTO, SENECA, SHELBY, STARK, SUMMIT,
TRUMBULL, TUSCARAWAS, UNION, VAN WERT,
VINTON, WARREN, WASHINGTON, WAYNE,
WILLIAMS, WOOD, WYANDOT

Special Jurisdictional Note :

Details :

SECTION M

***SPECIAL PROVISIONS/TECHNICAL
SPECIFICATIONS***

HAMILTON ROAD DRILLED PIER WALL PROJECT SPECIAL PROVISIONS/TECHNICAL SPECIFICATIONS

The 2023 Ohio Department of Transportation Construction and Material Specifications and the Supplemental Specifications shall govern this project unless stated otherwise by the Warren County Engineer, herein referred to as “Engineer”, “Project Engineer” and “County Engineer”.

Operations Schedule

The Contractor shall advise and coordinate all work with the Engineer. A detailed schedule of operations shall be furnished by the Contractor to the Engineer and shall list the order of operations and the time frame for the completion of each item of work. The Engineer and the Owner prior to the beginning of the work shall approve the schedule of operations. Changes to said schedule are to be issued in writing and approved by the Engineer before operations are changed or rescheduled. The Contractor shall schedule operations so that the improved areas have had sufficient time to cure, set and/or harden before the area is opened to traffic or use. The Contractor shall be responsible for the immediate repair of the improved area if any damage is done by traffic. The Contractor shall also be responsible for the immediate rectification of problems created in areas outside of the improved areas attributable to the failure of the improved area, i.e., the tracking of materials into unimproved areas.

Preconstruction Meeting

Prior to the commencement of the construction activities, the Warren County Engineer will arrange a meeting between the Contractor and the Warren County Engineer. The time, date and location of said meeting will be determined after the awarding of the contract, and all parties will be notified by the Warren County Engineer. At the preconstruction meeting the Contractor shall submit to the Project Manager a construction schedule, list of subcontractors, and list of suppliers.

Project Start Date

The Contractor shall begin the construction once a written notice-to-proceed has been given by the Board of Warren County Commissioners and a preconstruction meeting has been held. There is a bridge rehabilitation project on McClure Road (71-0.39) that is to be completed before the start of this pier wall project. The estimated project completion date for the bridge rehabilitation is October 4, 2024. This project is expected to start on October 7, 2024.

Completion Time

All work for the Hamilton Road Pier Wall shall be completed within 4 weeks after the start of construction. All work shall be completed by May 31, 2025, with substantial work completed by December 31, 2024. Work on the pier wall shall begin after the written notice-to-proceed has been issued by the Board of Warren County Commissioners and a preconstruction meeting has been held. Liquidated damages for non-completion beyond the specified duration of construction for a specific pier wall and/or May 31, 2025 shall follow the ODOT CMS Section 108.07. Once work has started it shall be expected that work will be performed every work day on the project in an expeditious manner until the project is complete unless of inclement weather.

HAMILTON ROAD DRILLED PIER WALL PROJECT SPECIAL PROVISIONS/TECHNICAL SPECIFICATIONS

Working Restrictions

No work shall be done between 5:00 p.m Friday and 7:00 a.m. Monday or during holidays. In addition, night work of any type shall be strictly prohibited.

Payment of Work

Contractor Estimates shall not be submitted more than once a month to the County Engineer for work included in the Contract between the County Commissioners and the Contractor.

Retainage and Affidavits

The contractor shall provide the County Engineer with affidavits stating that all subcontractors and suppliers for this project have been paid in full in accordance with Item 109. A percentage of the original contract bid amount shall be retained on this project. Until 50% of the original contract has been performed, 8% of the amount of work performed will be retained. Once 50% of the contract has been performed and thereafter, a total of 4% of the original contract bid amount will be retained. The entire retainage will be released to the Contractor after the final inspection has been performed, after the County Engineer has accepted the construction and after all affidavits have been submitted to the County Engineer by the Contractor.

Change Orders

No change orders involving performance or nonperformance contract quantities of project materials shall be processed without direct approval by the Warren County Engineer.

Storage of Construction Materials

The Contractor shall obtain prior approval of the Owner and/or Engineer for the locations to be used for the temporary storage of construction materials, tools, and/or machinery. All such materials, tools, and machinery shall be neatly and compactly piled in such a manner as to cause the least inconvenience to the property owners and to traffic. Under no circumstances shall existing drainage courses be blocked or water hydrants, valves, or meter pits covered.

Protection of Areas Outside of Work Limits

The work limits shall be confined to the existing 60 foot right-of-way of Hamilton Road. The Contractor shall be responsible for the protection of areas outside of the designated work limits, but which may be adjacent to those work limits. This will include those areas used by construction traffic for access to and from the work areas. Where the Engineer determines that the Contractor's operations have been responsible for damage to areas outside of the work limits, the Contractor shall be responsible for the repair of the area subject to the approval of the Engineer. No additional compensation will be due to the Contractor for any repair of these areas.

HAMILTON ROAD DRILLED PIER WALL PROJECT SPECIAL PROVISIONS/TECHNICAL SPECIFICATIONS

Debris Removal

The Contractor will be responsible for removal from the site of all construction debris material. All debris material shall be disposed of in a proper manner and shall be as directed by any applicable local, state or federal regulations.

Utility Notification

The Contractor shall notify at least 48 hours before breaking ground all public and/or private service corporation having wires, poles, conduits, manholes, or other structures that may be affected by the construction on this project, including all structures which are affected and not shown on the plans. Owners of underground utilities, which are members of OUPS, can be notified by calling 1-800-362-2764. Non-member underground utility owners must be called directly.

Utility Adjustments

The Contractor shall adjust to proposed grade all existing utility facilities, i.e. manholes, catch basins, valves, boxes, etc., prior to the commencement of paving operation. This shall include utility facilities, not shown on the plan, which may be found to be located within the pavement area. Work performed on the utility facilities shall be in strict accordance with the specifications of the applicable utility owner and shall be performed under the direction, supervision and inspection of said owner.

Existing Box Culvert

The location, size, type and depth of the existing box culvert is shown on the plans as according to the best information. The Engineer will not be responsible for any variations found during construction. The Contractor shall not disturb the box culvert.

Testing of Construction Materials

The Engineer may select a testing firm for this project. The Engineer will notify the Contractor of the selected firm during the pre-construction meeting. The Contractor shall be responsible for the scheduling of all testing as per the general testing requirements listed below or as modified by the Engineer. The Engineer shall be responsible for the costs incurred in the testing of the construction materials both on site and at the plant. However, the Contractor shall note that he will be responsible for any and all costs incurred by the scheduling and/or rescheduling of the testing firm's activities by the Contractor and the subsequent delay and/or cancellation of said activities due to the delay and/or cancellation of the scheduled construction by the Contractor.

HAMILTON ROAD DRILLED PIER WALL PROJECT SPECIAL PROVISIONS/TECHNICAL SPECIFICATIONS

Description of Work

The work to be done consists of furnishing all labor, tools, equipment and materials for the construction of drilled piers as well as for the paving, striping, and guardrail on Hamilton Road according to the plans and specifications.

Hamilton Road (TR 13) - located between McClure Road and SR63. This project consists of constructing 30" Diameter Reinforced Drilled Piers, 30" Diameter Unreinforced Drilled Piers, Cast-In-Place Concrete Lagging, placing Armormax slope stabilization fabric between the gap where the culvert lies, and placing Type 5 Guardrail.

Item 201 - Clearing and Grubbing

This work shall consist of clearing, grubbing, scalping, removal of trees and stumps, and removing and disposing of all vegetation and debris within the limits of the existing right-of-way as deemed necessary by the Engineer for the construction of the drilled pier wall, except such objects as are to remain or are to be removed in accordance with other sections of these specifications. Clearing, grubbing, and tree trimming and tree removal shall be kept to a minimum. Payment for the work listed above shall be included in the Lump Sum bid price for Item 201 Clearing and Grubbing.

Item 202 – Removals

This work shall consist of the removal, wholly or in part, and satisfactory disposal of all buildings, fences, guardrails, structures, old pavements, abandoned pipe lines, storage tanks, septic tanks, privy vaults, and any other obstructions which are not designated or permitted to remain, except for the obstructions to be removed and disposed of under other items in the contract. It shall also include the salvaging of designated materials and backfilling the resulting trenches, holes, and pits.

Item 203 - Excavation

The damaged existing asphalt pavement shall be removed as directed by the Engineer. The locations and depth of the excavations will be determined by the Engineer. The Contractor shall saw cut the pavement areas before it is removed to obtain a uniform edge. The cost of saw cutting, removing the existing asphalt pavement, and removing the base material shall be included in the unit price bid per CY for Item 203 Excavation.

Item 304 - Aggregate Base

All Item 304 Aggregate Base work shall be as directed by the Engineer. Where areas of unsuitable subgrade material are found, the unsuitable material shall be removed and Item 304 Aggregate Base shall be placed and compacted in the excavated areas. The removal of the material will be to the limits determined in the field by the Engineer, and the limits of the removal will be measured by the Engineer in order to determine quantities for payment. The Contractor shall be responsible for scheduling his operations with the Engineer so that the proper

HAMILTON ROAD DRILLED PIER WALL PROJECT SPECIAL PROVISIONS/TECHNICAL SPECIFICATIONS

measurements may be obtained for the calculations. Item 304 may also be used for roadway shoulder material as directed by the Engineer.

The Contractor shall place Item 304 Aggregate Base in the excavated areas where the unsuitable subgrade material was located, as directed by the Engineer. The depth shall be determined in the field by the Engineer. Item 304 Aggregate Base shall be compacted in compliance with section 304.05 of the ODOT Construction and Material Specifications.

Payment for the removal of unsuitable subgrade material and placement/compaction of Item 304 Aggregate Base shall be included in the price bid per CY for Item 304 Aggregate Base.

Asphalt Concrete

All material furnished and work performed shall conform to the 2023 Ohio Department of Transportation Construction and Material Specifications (ODOT CMS) for Item 301 Asphalt Concrete Base and Item 441 Asphalt Concrete Surface Course. All asphalt concrete work shall be as directed by the Engineer.

The Contractor shall supply the County Engineer with a weigh ticket for each load of material placed. Periodic asphalt samples will be obtained for test purposes and an independent testing laboratory will perform tests.

No material shall be placed upon collected water. Asphalt surfaces shall be clear of dirt and debris prior to the placing of each subsequent lift. The Contractor shall adhere to the judgment of the Warren County Engineer's designated representatives.

The Contractor's attention is directed to Section 401.14 of the ODOT Specifications and he is hereby instructed that requirements for preparation of asphalt pavement to be resurfaced will be adhered to, and cost of any and all cleaning is to be included in the unit bid price for Item 301 and Item 441.

Item 301 Asphalt Concrete Base shall be placed on top of the subgrade in two-5 inch lifts in the excavated areas. Item 301 Asphalt Concrete Base shall be placed at locations determined by the Engineer. Item 441 Asphalt Surface Course shall be placed on top of Item 301 and the existing asphalt in one to two inch leveling course as directed by the Engineer.

Item 407 Tack Coat shall be applied on top of the existing pavement or Item 301 Asphalt Concrete Base at a rate of 0.10 gallon per square yard as directed by the Warren County Engineer. The application of Item 407 Tack Coat shall be applied to the entire width of the asphalt base pavement immediately prior to paving the surface course. The cost of Item 407 Tack Coat shall be included in the cost per ton bid for Item 441 Asphalt Concrete Surface Course.

Butt Joints - A butt joint shall be constructed by grinding/planing existing pavement at each start/stop location. All grinding/ planing shall be in accordance with Item 254 Pavement Planing, Bituminous. The butt joints shall be constructed by grinding/planing the existing pavement for a

HAMILTON ROAD DRILLED PIER WALL PROJECT SPECIAL PROVISIONS/TECHNICAL SPECIFICATIONS

length of 6 feet, varying in depth from 2" to 0". The newly formed joint shall be properly installed so as to provide a smooth transition and shall also be properly sealed. The cost of constructing each butt joint by pavement planing/grinding shall be included and paid for in Item 441 Asphalt Concrete Surface Course.

Reinforcing Steel Alternates

The plans detail the reinforced drilled piers with Steel H-Piles (Alternate 1) and with Epoxy Coated Reinforcing (Alternate 2) on sheet 3. The Engineer will accept either Alternate selected by the Contractor. All reinforcing steel shall be paid for in the unit price bid per FT for Item 524 Drilled Shafts, 30" Diameter, Reinforced.

Item 524 – Drilled Shafts, 30" Diameter, Reinforced

Measurement:

Measurement for the piers will be the total number of lineal feet from the bottom of the drilled shaft to the top of the finished concrete pier. Payment will be made at the unit price bid per FT of Item 524 Drilled Shafts, 30" Diameter, Reinforced which will include full compensation for all forms, mobilizing and removing drilling equipment, satisfactory removal of drilling spoils, furnishing of liners and casings as required, concrete, reinforcing H-piles or steel cages, miscellaneous hardware, and all other incidentals necessary to complete this item.

Pier Log:

Each pier shall be numbered between S1 to S16 in the field for logging purposes. The numbers shall be permanently marked onto the top of each pier. The Contractor shall keep a log which includes the total depth of each pier. A copy of the log shall be provided to the County Engineer at the completion of the project. Measurement for the piers will be the total number of linear feet from the bottom of the drilled shaft to the top of the finished concrete pier.

Location of Drilled Piers:

All reinforced drilled piers shall be spaced 6'-3" from centerline of pier to centerline of pier as shown on the plans. The centerline of the piers shall be laterally offset off the edge of pavement such that the back edge of the structural piers is per the plan requirements from edge of pavement.

Reinforcing Steel:

If using steel H-piles for reinforcement they shall meet all the requirements of Item 507.07 Steel H-Piles, Grade 50. If using epoxy coated reinforcing for reinforcement it shall meet all the requirements of Item 509 Epoxy Coated Reinforcing, except the welding of ties to the longitudinal bars will not be permitted. Minimum yield strength of the epoxy coated reinforcing steel shall be 60,000 psi. Splices for epoxy coated reinforcing shall be lapped not less than 50" or welded to develop at least 125% of yield strength. No more than 50% of the tensile epoxy coated reinforcement in any one pier may be spliced. Epoxy coated reinforcing cages shall be securely and rigidly tied and accurately located in the forms and drilled shafts so as to maintain the clearance shown on the plans.

HAMILTON ROAD DRILLED PIER WALL PROJECT SPECIAL PROVISIONS/TECHNICAL SPECIFICATIONS

Concrete:

Concrete shall meet all requirements of Item 511 – Concrete for Structures. Concrete shall be Class QC 1 (28 day compressive strength = 4,000 psi). The aggregate shall have a maximum size of one inch (such as AASHTO #67 stone). The required slump is six (6) inches, plus or minus one-half inch. The above listed specifications for concrete supersede the specifications listed in the plan set referring to concrete and a maximum slump equal to four (4) inches. The maximum water to cement ratio shall be 0.50 if concrete is placed under water. The requirements of adding 10 percent more cement to the concrete mix shall be waived. Only a minimal vibratory effort is necessary. All concrete shall be placed with mechanical vibration. **Special care shall be taken not to over-vibrate the drilled shaft concrete. No horizontal construction joints will be permitted without the approval of the County Engineer.**

Drilling:

The center of the shaft shall be located within one inch (1") of plan location, and the shaft shall be plumb within one percent (1%) of its length. Any shafts varying by more than the above tolerances shall be corrected to the satisfaction of the County Engineer. Drilling shall extend through any materials which may be encountered, and shall penetrate a minimum depth, as detailed in the plans, into layered shale and/or limestone bedrock. Bottom elevation of piers shall be determined by the County Engineer. Temporary steel liners or casings shall be provided where necessary and as directed by the County Engineer to prevent caving or slipping of the shaft walls. Liners shall be withdrawn as the concrete is being placed, maintaining sufficient head of concrete within the liner to prevent the extraneous material from falling in from the sides of the shaft and mixing with the concrete. Drilling into the shale and limestone must be done with a core roller or other bit approved by the County Engineer, so that the sides of the shaft will be left smooth and firm without disturbed seams of rock. **All drilling spoils shall be hauled off-site.** Interfering Objects - Any objects such as fence, signs, brush, tree limbs, etc., which interfere with the drilling and placement of the Piers, shall be removed by the Contractor as directed by the County Engineer. The cost of removing any interfering objects, which are not designated as a separate removal, shall be included in the unit price bid per FT of Item 524 Drilled Shafts, 30" Diameter, Reinforced.

Forms:

Forms shall be truly cylindrical in shape without any bulges or depressions, and be plumb and securely braced so that the centerline of the top of the pier is within one inch (1") of the plan location. The top of the form shall be cut to the elevation of the top of the pier so the concrete can be finished smooth and level. Sonotube, or an equal, with an interior diameter matching the diameter of the drilled shaft, shall be used to form the top of the shaft up to the top of the pier. The cost of the sonotube shall be included in the unit price bid per FT of Item 524 Drilled Shafts, 30" Diameter, Reinforced.

Concrete Placement:

The concrete for the drilled shafts shall be placed as per Item 511. The concrete placement operation shall be continuous from start to finish. The concrete for the bedrock socket shall be placed against the insitu bedrock and shall be placed promptly after the final inspection of the shaft. If practicable, the concrete shall be placed in a clean dry excavation. Care shall be taken to ensure that concrete is not being placed in moving water. The concrete can be placed in a dry

HAMILTON ROAD DRILLED PIER WALL PROJECT SPECIAL PROVISIONS/TECHNICAL SPECIFICATIONS

drilled shaft excavation by the free fall method provided the concrete falls to its final position through air without striking the sides of the hole, the reinforcing steel, or any other obstruction. The free fall method allows the concrete to be dropped from the top through a centering chute to the concrete's final position. If the engineer determines that dewatering is not practicable, the contractor will be given permission to place the concrete under water. To place concrete under water, the drilled shaft excavation shall be filled with water to such a depth that all water motion ceases. The concrete shall then be placed by means of a concrete pump. The concrete pump pipe shall have a diameter that is not less than 4 inches. The concrete pump equipment shall be so arranged that no vibrations result which might damage fresh concrete. Pipes carrying concrete from the pump to the shaft should be arranged with a minimum number of bends. The pipe used to convey the concrete to the bottom of the drilled shaft excavation shall be anchored to the steel casing to prevent the pipe from undulating during the initial placement of the concrete. The pumping equipment shall be suitable in kind and adequate in capacity for the work required. The use of aluminum pipe as a conveyance for the concrete will not be permitted. An adequate quantity of grout, mortar or concrete with coarse aggregate omitted shall be pumped through the equipment ahead of the specification concrete to provide lubrication to the pumping system. The concrete used for lubrication shall not be placed in the shaft. The lubrication process will not be repeated as long as the pumping operations are continuous. The operation of the pump shall be such that a continuous stream of concrete without air pockets is produced, in order to prevent the contamination of the concrete placed initially at the bottom of the shaft. The outlet end of the pumping pipe shall be sealed with a diaphragm or plug that is flushed out when the hydrostatic pressure from the column of concrete exceeds that of the water in the shaft. The initial rate of concrete placement must be carefully controlled so as not to lift or displace the reinforcing steel. The conveying system shall be water tight and the outlet end shall always remain well below the top of the freshly placed concrete. The preferred concrete placement procedure is to maintain the outlet end of the pumping system at approximately 15 feet below the top of the fresh concrete. When the concrete reaches the top of the drilled shaft column all laitance shall be removed. The cost of dewatering or adding water and concrete pump shall be included in the unit price bid per FT of Item 524 Drilled Shafts, 30" Diameter, Reinforced.

Item 524 – Drilled Shafts, 30" Diameter, Unreinforced

Measurement:

Measurement for the piers will be the total number of lineal feet from the bottom of the drilled shaft to the top of the finished concrete pier. Payment will be made at the unit price bid per FT of Item 524 Drilled Shafts, 30" Diameter, Unreinforced which will include full compensation for all forms, mobilizing and removing drilling equipment, satisfactory removal of drilling spoils, furnishing of liners and casings as required, concrete, miscellaneous hardware, and all other incidentals necessary to complete this item.

Pier Log:

Each pier shall be numbered between P1 to P28 in the field for logging purposes. The numbers shall be permanently marked onto the top of each pier. The Contractor shall keep a log which includes the total depth of each pier. A copy of the log shall be provided to the County Engineer at the completion of the project. Measurement for the piers will be the total number of linear feet from the bottom of the drilled shaft to the top of the finished concrete pier.

HAMILTON ROAD DRILLED PIER WALL PROJECT SPECIAL PROVISIONS/TECHNICAL SPECIFICATIONS

Location of Drilled Piers:

All unreinforced drilled piers shall be used as lagging between the reinforced drilled piers as shown on the plans. The centerline of the plug piers shall be laterally offset off the edge of pavement per plan for 30" diameter plug piers.

Concrete:

Concrete shall meet all requirements of Item 511 – Concrete for Structures. Concrete shall be Class QC 1 (28 day compressive strength = 2,500 psi). The aggregate shall have a maximum size of one inch (such as AASHTO #67 stone). The required slump is six (6) inches, plus or minus one-half inch. The above listed specifications for concrete supersede the specifications listed in the plan set referring to concrete and a maximum slump equal to four (4) inches. The maximum water to cement ratio shall be 0.50 if concrete is placed under water. The requirements of adding 10 percent more cement to the concrete mix shall be waived. Only a minimal vibratory effort is necessary. All concrete shall be placed with mechanical vibration. **Special care shall be taken not to over-vibrate the drilled shaft concrete. No horizontal construction joints will be permitted without the approval of the County Engineer.**

Drilling:

The center of the shaft shall be located within one inch (1") of plan location, and the shaft shall be plumb within one percent (1%) of its length. Any shafts varying by more than the above tolerances shall be corrected to the satisfaction of the County Engineer. Drilling shall extend through any materials which may be encountered, as detailed in the plans. Bottom elevation of piers shall be determined by the County Engineer. Temporary steel liners or casings shall be provided where necessary and as directed by the County Engineer to prevent caving or slipping of the shaft walls. Liners shall be withdrawn as the concrete is being placed, maintaining sufficient head of concrete within the liner to prevent the extraneous material from falling in from the sides of the shaft and mixing with the concrete. **All drilling spoils shall be hauled off-site.** Interfering Objects - Any objects such as fence, signs, brush, tree limbs, etc., which interfere with the drilling and placement of the Piers, shall be removed by the Contractor as directed by the County Engineer. The cost of removing any interfering objects, which are not designated as a separate removal, shall be included in the unit price bid per FT of Item 524 Drilled Shafts, 30" Diameter, Unreinforced.

Forms:

Forms shall be truly cylindrical in shape without any bulges or depressions, and be plumb and securely braced so that the centerline of the top of the pier is within one inch (1") of the plan location. The top of the form shall be cut to the elevation of the top of the pier so the concrete can be finished smooth and level. Sonotube, or an equal, with an interior diameter matching the diameter of the drilled shaft, shall be used to form the top of the shaft up to the top of the pier. The cost of the sonotube shall be included in the unit price bid per FT of Item 524 Drilled Shafts, 30" Diameter, Unreinforced.

Concrete Placement:

The concrete for the drilled shafts shall be placed as per Item 511. The concrete placement operation shall be continuous from start to finish. The concrete shall be placed promptly after the

HAMILTON ROAD DRILLED PIER WALL PROJECT SPECIAL PROVISIONS/TECHNICAL SPECIFICATIONS

final inspection of the shaft. If practicable, the concrete shall be placed in a clean dry excavation. Care shall be taken to ensure that concrete is not being placed in moving water. The concrete can be placed in a dry drilled shaft excavation by the free fall method provided the concrete falls to its final position through air without striking the sides of the hole or any other obstruction. The free fall method allows the concrete to be dropped from the top through a centering chute to the concrete's final position. If the engineer determines that dewatering is not practicable, the contractor will be given permission to place the concrete under water. To place concrete under water, the drilled shaft excavation shall be filled with water to such a depth that all water motion ceases. The concrete shall then be placed by means of a concrete pump. The concrete pump pipe shall have a diameter that is not less than 4 inches. The concrete pump equipment shall be so arranged that no vibrations result which might damage fresh concrete. Pipes carrying concrete from the pump to the shaft should be arranged with a minimum number of bends. The pipe used to convey the concrete to the bottom of the drilled shaft excavation shall be anchored to the steel casing to prevent the pipe from undulating during the initial placement of the concrete. The pumping equipment shall be suitable in kind and adequate in capacity for the work required. The use of aluminum pipe as a conveyance for the concrete will not be permitted. An adequate quantity of grout, mortar or concrete with coarse aggregate omitted shall be pumped through the equipment ahead of the specification concrete to provide lubrication to the pumping system. The concrete used for lubrication shall not be placed in the shaft. The lubrication process will not be repeated as long as the pumping operations are continuous. The operation of the pump shall be such that a continuous stream of concrete without air pockets is produced, in order to prevent the contamination of the concrete placed initially at the bottom of the shaft. The outlet end of the pumping pipe shall be sealed with a diaphragm or plug that is flushed out when the hydrostatic pressure from the column of concrete exceeds that of the water in the shaft. The conveying system shall be water tight and the outlet end shall always remain well below the top of the freshly placed concrete. When the concrete reaches the top of the drilled shaft column all laitance shall be removed. The cost of dewatering or adding water and concrete pump shall be included in the unit price bid per FT of Item 524 Drilled Shafts, 30" Diameter, Unreinforced.

Item 606 – Guardrail, Type 5

The Contractor shall install new guardrail on both sides of the road, replacing the existing guardrail with the same lengths. The Contractor shall install the new Type 5 guardrail posts, in the front of the structural piers at 6'-3" on center. This work shall conform to the Ohio Department of Transportation's Plan Insert Sheet GR 2.1. Type 5 Guardrail shall also include the placement of reflective material on each new end treatments. Payment for the work listed above shall be included in the price bid per FT for Item 606 Guardrail.

Item 614 - Maintaining Traffic

Traffic control shall be the sole responsibility of the Contractor. The County of Warren shall be held harmless from liabilities caused by improper traffic control by the Contractor. The contractor shall indemnify Warren County from any and all liabilities due to improper maintenance of traffic. All road construction signs shall also be the responsibility of the Contractor. All traffic control shall conform to the Ohio Manual of Uniform Traffic Control Devices (OMUTCD) as well as the Ohio Department of Transportation Standards at all times.

HAMILTON ROAD DRILLED PIER WALL PROJECT SPECIAL PROVISIONS/TECHNICAL SPECIFICATIONS

Any devices that are determined by the Engineer to be substandard shall be repaired to the satisfaction of the Engineer or shall be immediately removed from the site and replaced with acceptable devices. Any temporary traffic control devices that are determined by the Engineer to have become substandard during the course of the project shall be removed from the jobsite and immediately replaced by devices meeting the approval of the Engineer.

The Contractor shall provide and maintain all signs, barricades, labor, flagmen, steel plates, etc. for all work on this project. The Contractor shall notify the Warren County Engineer two (2) weeks prior to any road closure. The Contractor shall install the advanced closure signs two (2) weeks prior to any road closure. The Contractor shall provide a minimum of two (2) Type III Barricades on each end of the closed section of each Road. The barricades shall be chain linked together and fixed to the ground or some other object over night.

Methods of maintaining traffic shall conform to the Manual of Uniform Traffic Control Devices and Item 614 of the ODOT Specifications. Payment for the work listed above shall be included in the Lump Sum bid price for Item 614 Maintaining Traffic.

Detour Route

Hamilton Road shall each be closed during the entire drilled pier wall project. The detour routes are detailed on the last page of the plan set. Any changes shall be as directed by the Engineer. The payment for all work associated with the road closure and detour shall be included in the Lump Sum bid price for Item 614 Maintaining Traffic.

Item 623 - Construction Layout Stakes and Surveying

All centerline of survey and property line monumentation that is disturbed during construction shall be reset by a Professional Surveyor. Payment for the work listed above shall be included in the Lump Sum bid price for Item 623 Construction Layout Stakes.

Pavement Marking

All pavement marking material and work shall comply with Item 641 Pavement Marking-General, Item 642 Traffic Paint, Type 1 in the current ODOT Construction and Materials Specifications.

Item 653 – Topsoil Furnished and Placed

All applications of topsoil shall be applied as directed by the Engineer. Payment for the application shall be included in the bid price per CY for Item 653 Topsoil Furnished and Placed. The contractor shall submit supporting documentation concerning the applications. This does not include the topsoil to be installed over the Armormax 75 area.

**HAMILTON ROAD DRILLED PIER WALL PROJECT
SPECIAL PROVISIONS/TECHNICAL SPECIFICATIONS**

Item 659 – Seeding and Mulching

All applications of seeding and mulching shall be applied as directed by the Engineer. Payment for the application shall be included in the bid price per SY for Item 659 Seeding & Mulching. The contractor shall submit supporting documentation concerning the applications. This does not include the seeding and mulching to be installed over the Armormax 75 area.

Item Special – Armormax 75

Installation of the Armormax 75 is to be in accordance with the notes and details on page 5 of the plans. The Armormax 75 shall be placed in between piers S8 and S9 to avoid drilling near the 4'x4' box culvert, as the plans suggest on page 2 of the plans. The Armormax 75 shall only be installed from the edge of the road to 30 feet from the center of the road. The plans show otherwise; however, the right-of-way line stops 30 feet from the center of the road. The payment for all work associated with the Armormax 75 installation, including topsoil and seeding and mulching, shall be included in the Lump Sum bid price for Item Special Armormax 75.

Soil Boring Logs

The soil boring log is located at the end of technical specifications as well as on sheet 6 of the construction plan set.

WARREN COUNTY ENGINEER'S OFFICE

HAMILTON ROAD (CR13) LANDSLIDE REMEDIATION

WARREN COUNTY, OHIO

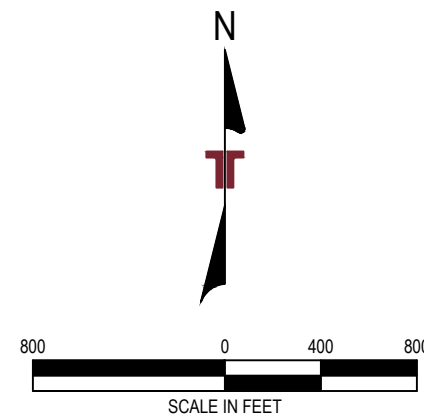
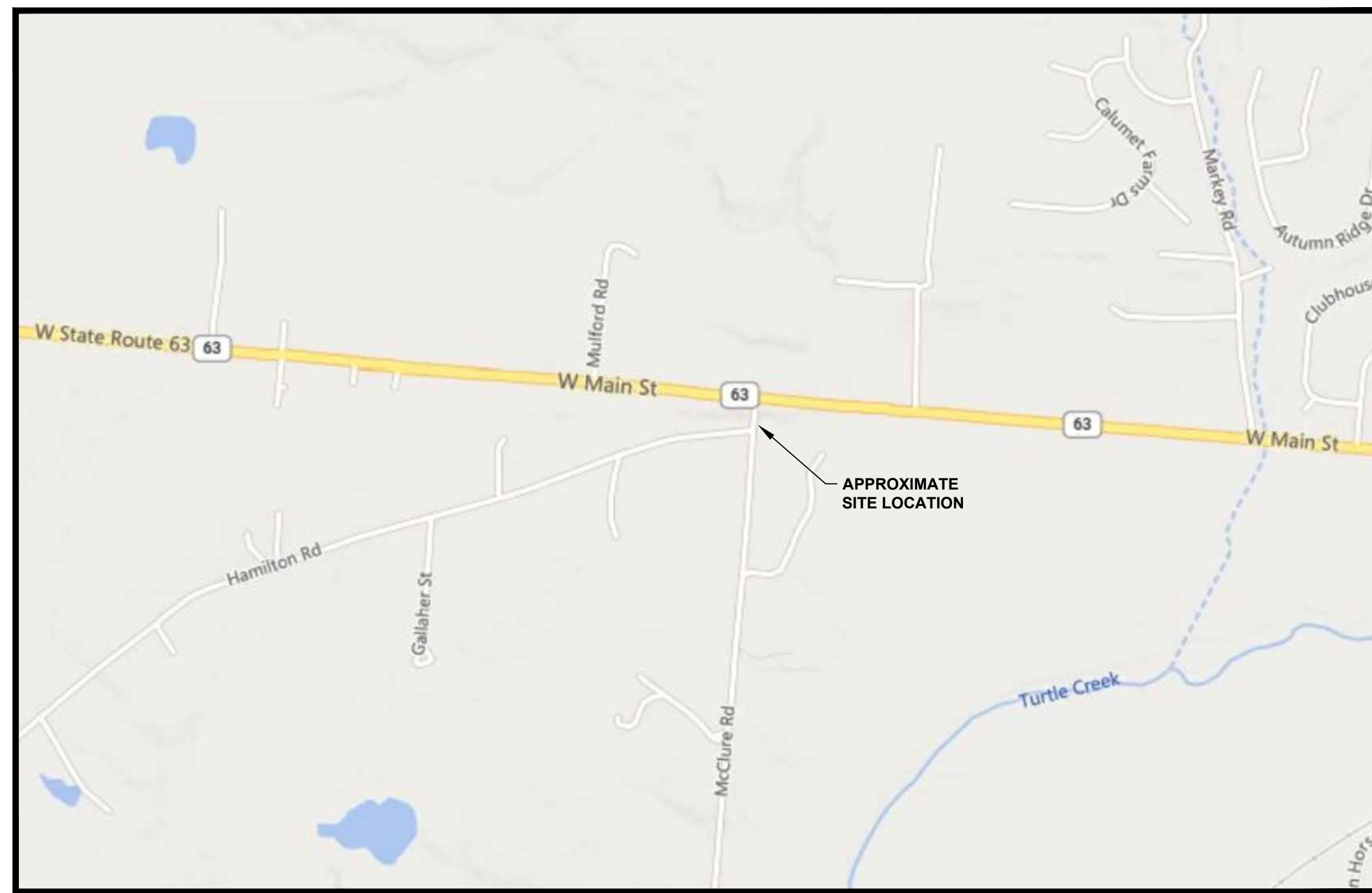

VICINITY MAP

APPROVED: WARREN COUNTY ENGINEER

DATE _____

APPROVED: WARREN COUNTY COMMISSIONERS

DATE _____

REV. DATE BY DESCRIPTION

COVER SHEET/SITE LOCATION

LANDSLIDE REMEDIATION
WARREN COUNTY ENGINEER'S OFFICE
 WARREN COUNTY, OHIO

Terracon
 Consulting Engineers and Scientists
 611 LUNKEN PARK DRIVE
 PH: (513) 321-5816
 CINCINNATI, OHIO 45228
 WWW.TERRACON.COM

EXHIBIT 1

DESIGNED BY:	PO
DRAWN BY:	DAB
APP'D BY:	DWW
SCALE:	as noted
DATE:	12/5/2023
JOB NO.:	N1235343
ACAD NO.:	planset6
SHEET NO.:	1 OF 6

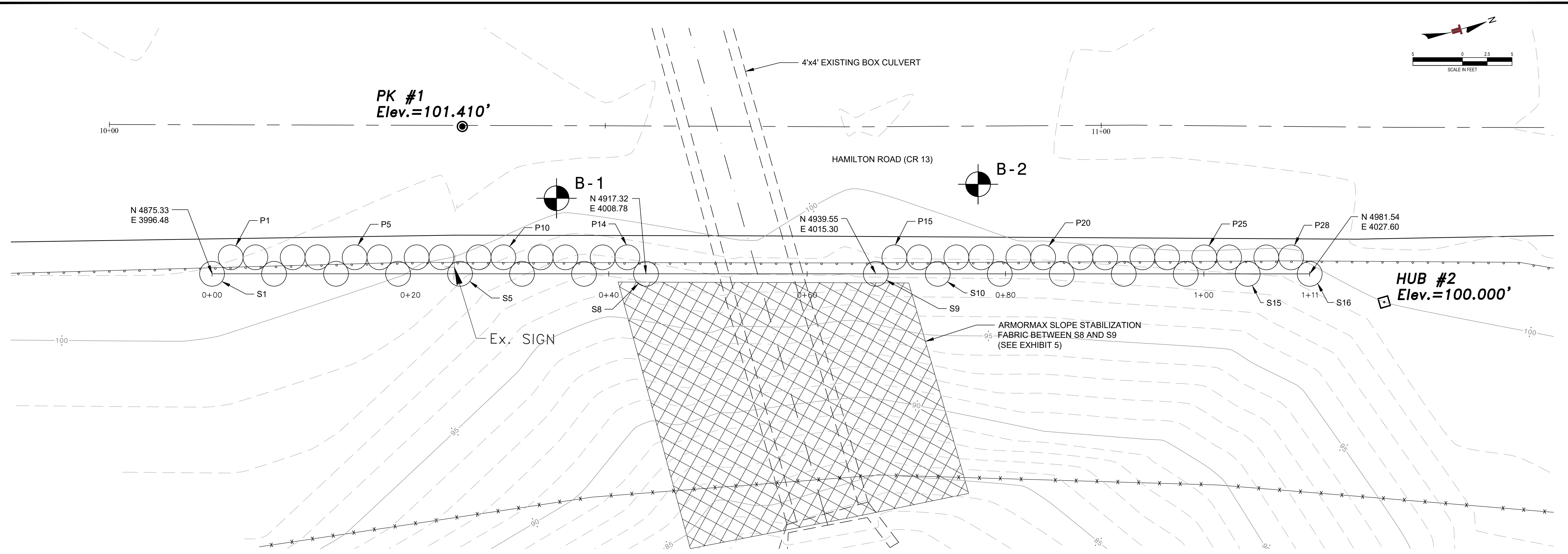

PLAN VIEW
SCALE: 1"=5'

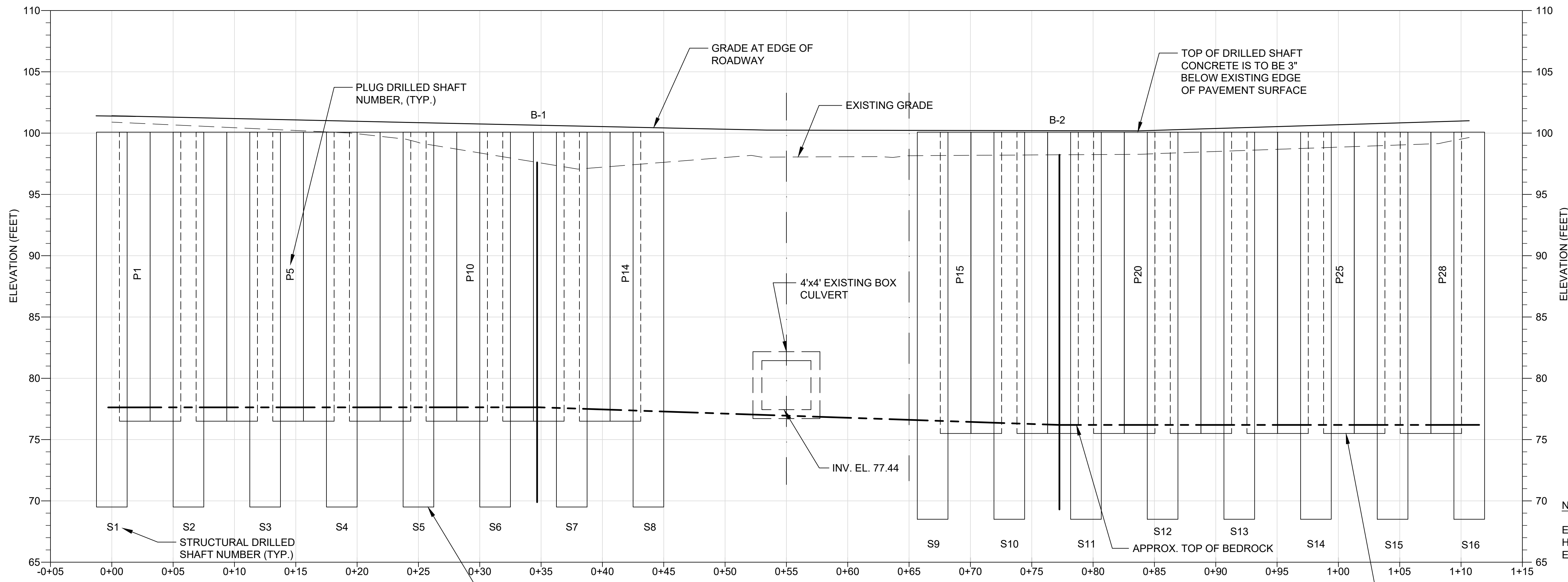

ELEVATION VIEW
SCALE: 1"=5' H&V

NOTE:
ELEVATIONS REFERENCE PK #1 AND HUB #2 PLACED BY WARREN COUNTY ENGINEERS OFFICE.

REV.	DATE	BY	DESCRIPTION

PLAN AND ELEVATION VIEW
LANDSLIDE REMEDIATION
WARREN COUNTY ENGINEER'S OFFICE
WARREN COUNTY, OHIO

Terracon
Consulting Engineers and Scientists
511 LUNKEN PARK DRIVE
PH: (513) 321-5816
CINCINNATI, OHIO 45226
WWW.TERRACON.COM

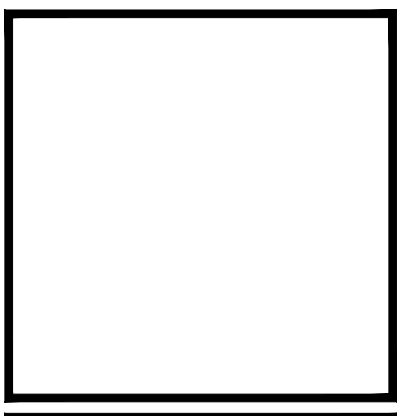
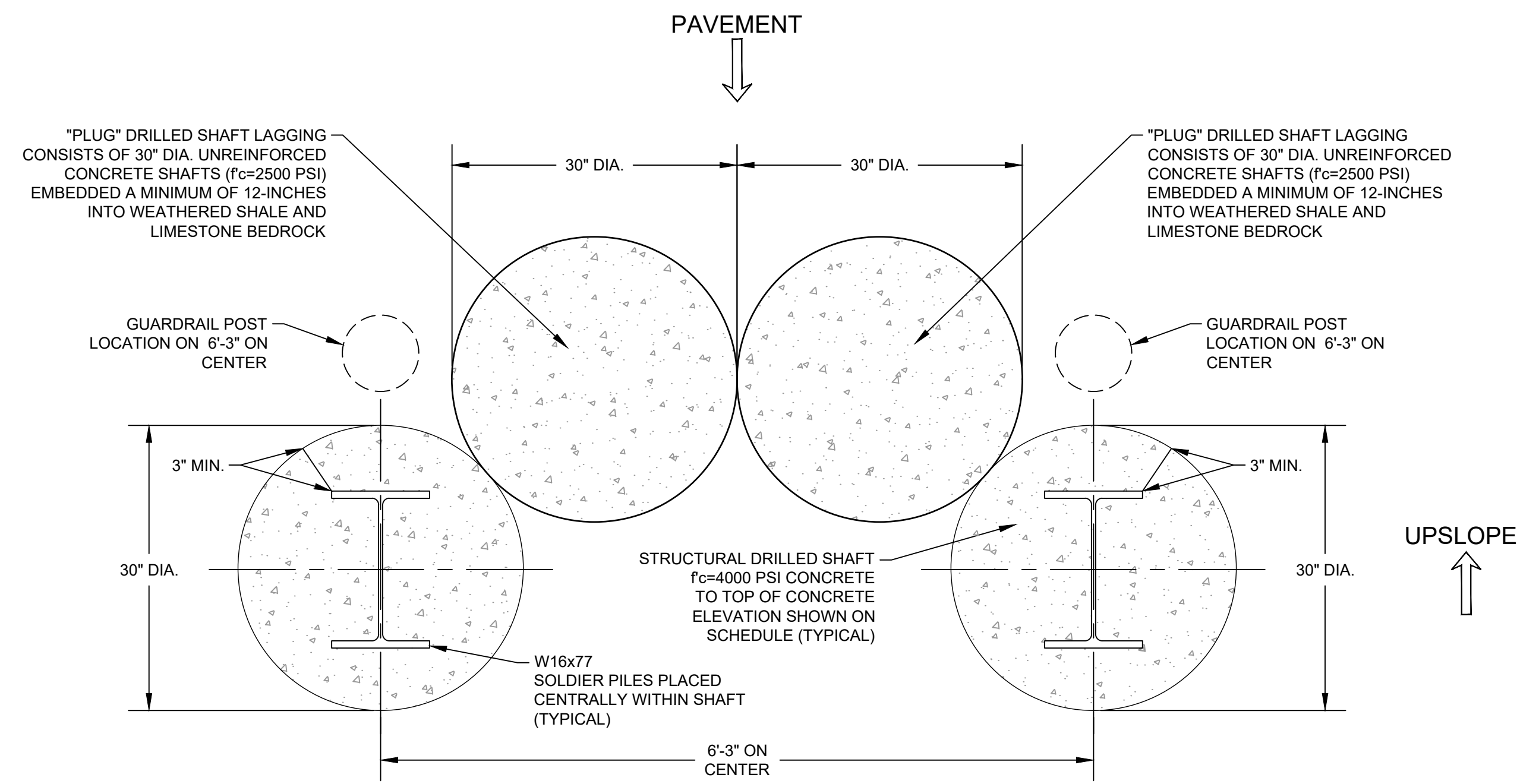
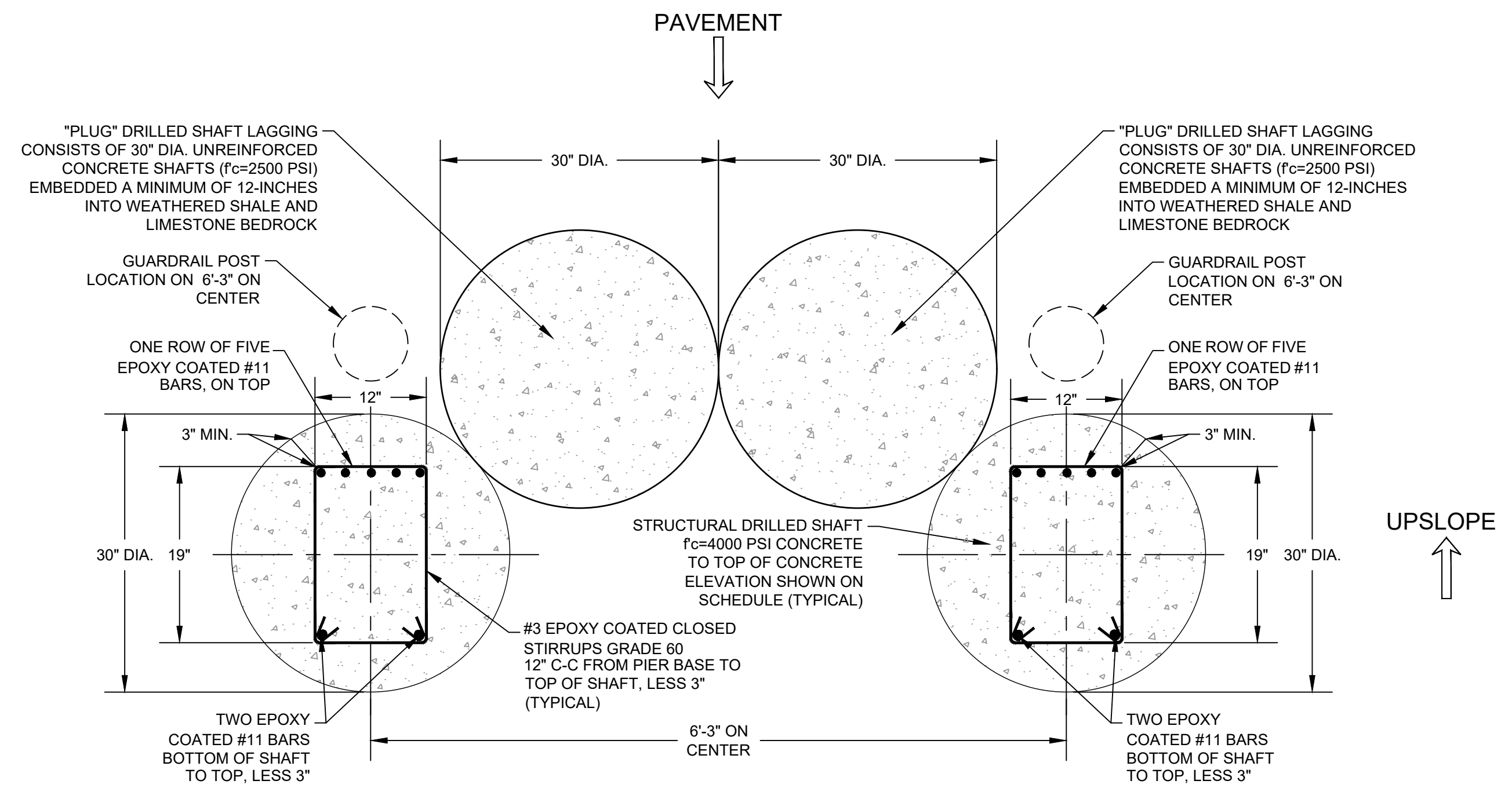

EXHIBIT 2

DESIGNED BY:	PO
DRAWN BY:	DAB
APPVD. BY:	DWW
SCALE:	1"=5'
DATE:	12/5/2023
JOB NO.:	N1235343
ACAD NO.:	planset6
SHEET NO.:	2 OF 6



REINFORCING ALTERNATE #1: STRUCTURAL DRILLED SHAFT WITH W16x77 REINFORCEMENT DETAIL AND "PLUG" SHAFT LAGGING
SCALE: 1"=1'



REINFORCING ALTERNATE #2: STRUCTURAL DRILLED SHAFT WITH CAGE REINFORCEMENT DETAIL AND "PLUG" SHAFT LAGGING
SCALE: 1"=1'

REV. DATE BY DESCRIPTION

DETAILS
LANDSLIDE REMEDIATION
WARREN COUNTY ENGINEER'S OFFICE
WARREN COUNTY, OHIO

Terracon
Consulting Engineers and Scientists
611 LUNKEN PARK DRIVE
PH: (513) 321-5816
CINCINNATI, OHIO 45226
WWW.TERRACON.COM

EXHIBIT 3

DESIGNED BY:	PO
DRAWN BY:	DAB
APPVD. BY:	DWW
SCALE:	as noted
DATE:	12/5/2023
JOB NO.:	N1235343
ACAD NO.:	planset18
SHEET NO.:	3 OF 6

DESCRIPTION

REV | DATE | BY

DETAILS AND CONSTRUCTION NOTES

LANDSLIDE REMEDIATION
WARREN COUNTY ENGINEER'S OFFICE
WARREN COUNTY, OHIO

EXHIBIT 4

DESIGNED BY: PO
DRAWN BY: DAB
APPVD. BY: DWW
SCALE: as noted
DATE: 12/5/2023
JOB NO. N1235343
ACAD NO. plansetB
SHEET NO.: 4 OF 6

611 LUNKEN PARK DRIVE
CINCINNATI, OHIO 45226
PH: (513) 521-5816
WWW.TERRACON.COM

Terracon
Consulting Engineers and Scientists

DRILLED SHAFT CONSTRUCTION NOTES

DRILLED SHAFT INSTALLATION

- CONSTRUCT THE RETAINING WALL CONSISTING OF 30-INCH DRILLED STRUCTURAL SHAFTS USING ROLLED STEEL SECTIONS OR STEEL CAGE REINFORCEMENT. THE PURPOSE OF THIS WORK IS TO STOP LATERAL CREEP-TYPE MOVEMENT ON THE DOWNSLOPE (EAST) SIDE OF HAMILTON RD (CR13). THE CONTRACTOR IS RESPONSIBLE FOR CLEARING OVERHEAD AND UNDERGROUND UTILITIES AND PROVIDING ACCESS FOR EQUIPMENT. THE SHAFT EXCAVATION SHALL BE UNCLASSIFIED.
- THE REINFORCED DRILLED SHAFT RETAINING WALL WILL CONSIST OF DRILLED SHAFTS SPACED APPROXIMATELY ON 6 FEET -3 INCHES (6'-3") ON CENTER, AS SHOWN ON THE SITE PLAN DRAWING. ESTIMATED EMBEDMENT DEPTHS INTO INTERBEDDED SHALE AND LIMESTONE BEDROCK ARE SHOWN ON THE DRILLED SHAFT SCHEDULE TABLE ON THIS SHEET; HOWEVER, ACTUAL EMBEDMENT DEPTHS WILL BE BASED ON ACTUAL FIELD CONDITIONS AS DETERMINED BY THE GEOTECHNICAL CONSULTANT.
- THE SHAFTS SHALL BE LOCATED AS SHOWN ON PLAN WITHIN 6" OF PLAN LOCATION. THE SHAFTS SHALL MAINTAIN A PLUMBNESS DEVIATION OF A MAXIMUM OF 1" IN 12 FT. VERTICAL HEIGHT. A MINIMUM 3" CONCRETE COVER BETWEEN THE REINFORCING STEEL AND THE EXTERIOR (SIDES AND TOP) OF THE DRILLED SHAFT SHALL BE PROVIDED.
- TWO ALTERNATIVES FOR REINFORCEMENT OF STRUCTURAL SHAFTS HAVE BEEN PROVIDED. REINFORCEMENT FOR THE STRUCTURAL SHAFTS SHALL CONSIST OF EITHER ROLLED STEEL SECTIONS HAVING YIELD STRENGTH OF 50 KSI OR EPOXY COATED CAGE REINFORCING STEEL HAVING A YIELD STRENGTH OF 60 KSI. ROLLED STEEL SECTIONS SHOULD CONSIST OF W16X77 (OR ALTERNATE APPROVED BY ENGINEER) AS NOTED ON THE PLANS. THE CONFIGURATION OF THE STEEL REINFORCING CAGE HAS BEEN SHOWN ON THE PLANS.
- THE PRE-DRILLED SHAFT WILL BE BACKFILLED WITH CONCRETE TO THE TOP OF CONCRETE ELEVATION. THE TOP OF SHAFT CONCRETE ELEVATION SHALL BE ABOUT 3 INCHES BELOW THE APPROXIMATE EDGE OF PAVEMENT ELEVATION. TO AVOID CONTACT BY SNOWPLOWS, STRUCTURE SHAFT CONCRETE SHALL BE CONCRETE (28-DAY FC = 4000 PSI, MAXIMUM SLUMP = 6 INCHES; 4% TO 6% AIR ENTRAINMENT) PLACED USING FREE FALL METHOD OF PLACEMENT. CONCRETE SHALL BE PLACED INTO EACH SHAFT EXCAVATION ON THE SAME DAY THAT THE DRILLING IS COMPLETED.
- TEMPORARY STEEL CASING SHOULD BE ON-SITE AND USED WHEREVER REQUIRED TO STABILIZE LOOSE OR CAVING MATERIALS, OR TO SEAL OFF WATER BEARING ZONES ENCOUNTERED DURING CONSTRUCTION.
- THE WALL DESIGN IS BASED ON MAXIMUM DEPTH TO WEATHERED INTERBEDDED SHALE AND LIMESTONE BEDROCK VARIES FROM 23 TO 24 FEET BELOW GRADE AS NOTED IN THE DRILLED SHAFT SCHEDULE. HOWEVER, IF BEDROCK IS ENCOUNTERED MORE THAN 1.0 FT. BELOW PLAN DESIGN ELEVATION, TERRACON SHALL BE NOTIFIED IMMEDIATELY TO REVIEW AND PROVIDE ADDITIONAL RECOMMENDATIONS. EACH SHAFT SHALL BE SOCKETED INTO BEDROCK A MINIMUM OF 8 FEET, AS DESCRIBED ON THE PLANS.
- THE CONTRACTOR SHALL MAINTAIN A RECORD OF EACH SHAFT DRILLED, WHICH WILL INCLUDE AT A MINIMUM: SHAFT NUMBER; GROUND ELEVATION; SHAFT TOP ELEVATION; TOP OF WEATHERED BEDROCK ELEVATIONS; TOP OF UNWEATHERED (GRAY) BEDROCK ELEVATIONS; AS-BUILT ROCK SOCKET DEPTH; ELEVATION OF THE TOP OF THE SHAFT CONCRETE; DATE DRILLED; DATE COMPLETED; AND WEATHER CONDITIONS.
- IT IS ANTICIPATED THAT WATER MAY ENTER SOME OF THE SHAFT EXCAVATIONS. THE DEPTH OF PONDED WATER AT THE BOTTOM OF THE SHAFT EXCAVATIONS SHOULD NOT EXCEED 2 INCHES. PRIOR TO PLACING CONCRETE, IF THE WATER CANNOT BE PUMPED DOWN, TREMIE PLACEMENT METHODS WILL BE REQUIRED.
- THE DRILLED SHAFT EXCAVATIONS SHOULD BE INSPECTED BY A QUALIFIED GEOTECHNICAL REPRESENTATIVE TO CONFIRM THAT THE DRILLED SHAFTS ARE SOCKETED INTO BEDROCK ACCORDING TO DESIGN, AND THAT THE DRILLED SHAFTS HAVE BEEN CONSTRUCTED PER SPECIFICATIONS.

PLUG SHAFT INSTALLATION

- TWO 30-INCH DIAMETER PLUG SHAFTS CONSISTING OF UNREINFORCED CONCRETE (28-DAY FC = 2500 PSI, MAXIMUM SLUMP = 6 INCHES, 4% TO 6% AIR ENTRAINMENT) AS NOTED ON THE CROSS-SECTION DETAILS WILL ACT AS LAGGING FOR THE SHAFT WALL. THERE SHALL BE NO PLUG SHAFTS INSTALLED BETWEEN THE TWO STRUCTURAL PIERS ADJACENT TO THE ARMORMAX FABRIC (S8 AND S9).
- PLUG SHAFT INSTALLATION FOR THE DRILLED SHAFT RETAINING WALL SHALL BEGIN AFTER THE STRUCTURAL SHAFT ELEMENTS HAVE GAINED STRENGTH (AT LEAST 24 HOURS AFTER PLACEMENT OF STRUCTURAL SHAFT CONCRETE).
- THE TOP OF THE PLUG SHAFT CONCRETE SHALL BE ABOUT 3 INCHES BELOW THE EDGE OF PAVEMENT.
- THE BOTTOM OF ALL PLUG SHAFTS INSTALLED SHOULD EXTEND TO THE ELEVATIONS DETAILED IN THE DRILLED SHAFT SCHEDULE (A MINIMUM OF 12 INCHES BELOW TOP OF WEATHERED BEDROCK)

DRAINAGE AND OTHER CONSTRUCTION CONSIDERATIONS

NEW STRUCTURAL FILL MAY BE PLACED IN THE AREA WHERE ARMORMAX IS PLANNED AND/OR ON THE UPSLOPE SIDE OF SHAFTS TO RETAIN GRADE NEXT TO THE EDGE OF PAVEMENT. SONOTUBES OR EQUIVALENT WILL BE REQUIRED IN SOME AREAS, DUE TO THE STEEPLY SLOPING HILLSIDE BELOW THE WALL. FILL SHOULD BE PLACED AND COMPACTED PER ODOT SPECIFICATIONS (ITEM 203). ONLY HAND-OPERATED EQUIPMENT SHOULD BE USED WITHIN 5 FEET OF THE FRONT OF THE SHAFTS.

FIELD QUALITY CONTROL

A. OWNER WILL COORDINATE FIELD CONSTRUCTION INSPECTION AND REPORTING THROUGH IN-HOUSE PERSONNEL OR EXTERNAL TESTING AGENCY.

DOCUMENTATION SHALL INCLUDE THE FOLLOWING AT EACH DRILLED SHAFT:

- GROUND ELEVATION
- AS-BUILT SHAFT DIAMETER AND TOP AND BOTTOM SHAFT ELEVATIONS.
- TOP OF WEATHERED BEDROCK ELEVATION.
- TOP OF UNWEATHERED (GRAY) BEDROCK ELEVATION.
- DESCRIPTION OF ENCOUNTERED SOIL MATERIALS.
- DESCRIPTION, LOCATION, AND DIMENSIONS OF OBSTRUCTIONS.
- FINAL TOP CENTERLINE LOCATION AND DEVIATIONS FROM REQUIREMENTS.
- VARIATION OF SHAFT FROM PLUMB.
- DRILLED SHAFT EXCAVATING METHOD.
- LENGTH OF ROCK SOCKET.
- LEVELNESS OF SHAFT BOTTOM AND ADEQUACY OF CLEANOUT.
- GROUND-WATER CONDITIONS AND WATER-INFILTRATION RATE, DEPTH, AND PUMPING.
- DESCRIPTION, DIAMETER, AND TOP AND BOTTOM ELEVATIONS OF TEMPORARY OR PERMANENT CASINGS.
- DESCRIPTION OF SOIL OR WATER MOVEMENT, SIDEWALL STABILITY, LOSS OF GROUND, AND MEANS OF CONTROL.
- DATE AND TIME OF STARTING AND COMPLETING DRILLED SHAFT EXCAVATION.
- POSITION OF REINFORCING STEEL.
- CONCRETE PLACEMENT METHOD, INCLUDING DELAYS.
- ELEVATION OF CONCRETE DURING REMOVAL OF CASINGS.
- LOCATIONS OF CONSTRUCTION JOINTS, IF ANY.
- REMARKS, UNUSUAL CONDITIONS ENCOUNTERED, AND DEVIATIONS FROM REQUIREMENTS.

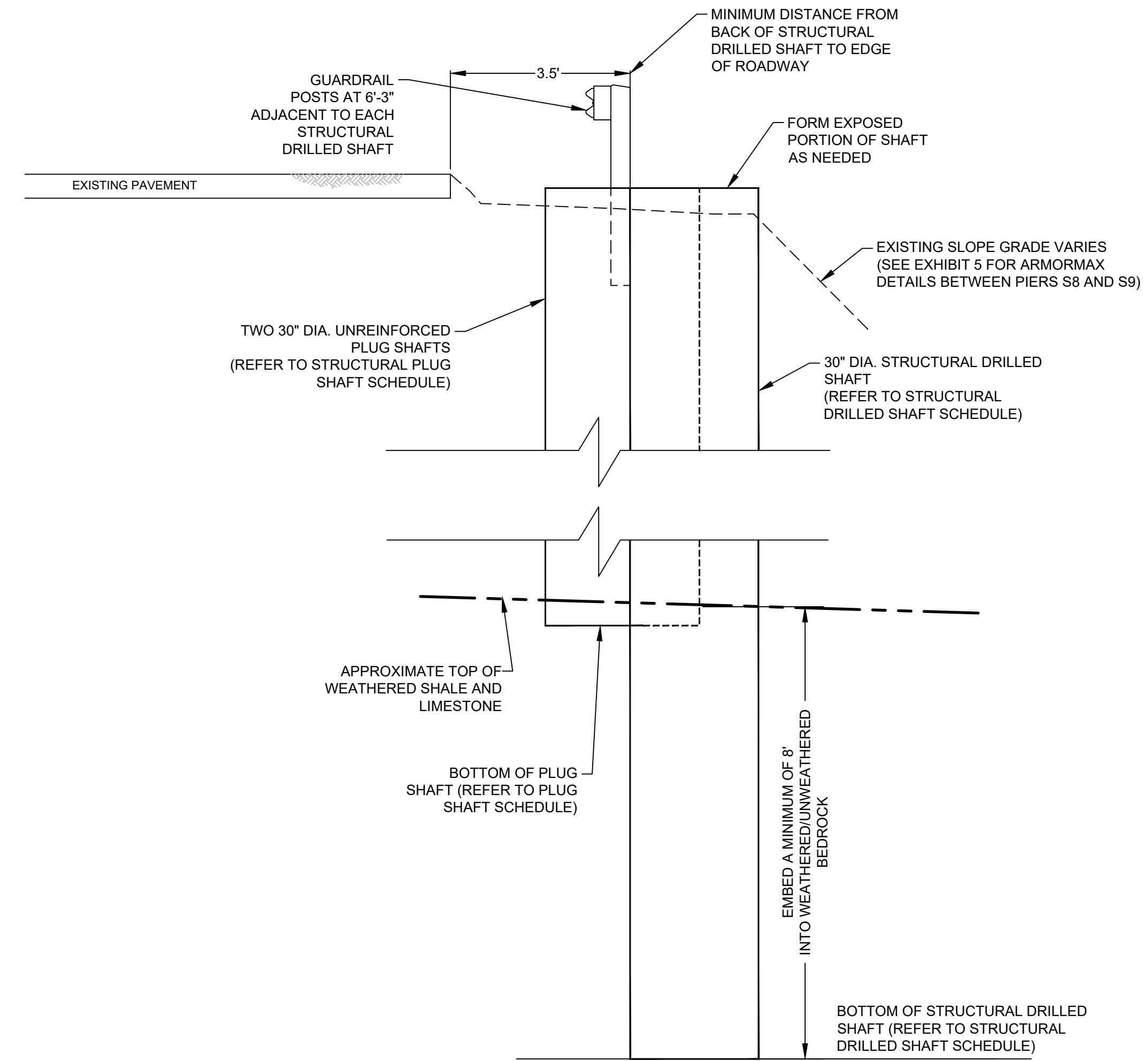

DRILLED SHAFT RETAINING WALL SECTION (TYPICAL)
SCALE: NOT TO SCALE

Structural Pier Schedule							
Pier No.	Diameter	Retaining Wall Station	Approx. Top of Pier Concrete Elevation ⁽¹⁾		Minimum Rock Socket Length	Estimated Drilled Pier Bottom Elevation ⁽³⁾	
			Feet	Feet		Feet	Feet
S1	30	0+0.00	100	77.5	8	69.5	30.5
S2	30	0+6.25	100	77.5	8	69.5	30.5
S3	30	0+12.50	100	77.5	8	69.5	30.5
S4	30	0+18.75	100	77.5	8	69.5	30.5
S5	30	0+25.00	100	77.5	8	69.5	30.5
S6	30	0+31.25	100	77.5	8	69.5	30.5
S7	30	0+37.50	100	77.5	8	69.5	30.5
S8	30	0+43.75	100	77.5	8	69.5	30.5
S9	30	0+67.25	100	76.5	8	68.5	31.5
S10	30	0+73.50	100	76.5	8	68.5	31.5
S11	30	0+79.75	100	76.5	8	68.5	31.5
S12	30	0+86.00	100	76.5	8	68.5	31.5
S13	30	0+92.25	100	76.5	8	68.5	31.5
S14	30	0+98.50	100	76.5	8	68.5	31.5
S15	30	1+4.25	100	76.5	8	68.5	31.5
S16	30	1+11.00	100	76.5	8	68.5	31.5

1) TOP OF PIER CONCRETE ELEVATION IS 3" BELOW THE APPROXIMATE EDGE OF ROADWAY SURFACE.
2) TOP OF BEDROCK SURFACE ANTICIPATED APPROXIMATELY 23 TO 24 FEET BELOW EXISTING SITE GRADES BASED ON TEST BORINGS. ACTUAL TOP OF BEDROCK SURFACE ELEVATIONS BETWEEN TEST BORING LOCATIONS MAY VARY AND WILL NEED TO BE VERIFIED IN THE FIELD.
3) ACTUAL LENGTH TO BE DETERMINED BY CONDITIONS IN THE FIELD.

Plug Pier Schedule				
Pier No.	Diameter	Approx. Top of Pier Concrete Elevation ⁽¹⁾		Estimated Drilled Pier Bottom Elevation
		Feet	Feet	
P1	30	100	76.5	23.5
P2	30	100	76.5	23.5
P3	30	100	76.5	23.5
P4	30	100	76.5	23.5
P5	30	100	76.5	23.5
P6	30	100	76.5	23.5
P7	30	100	76.5	23.5
P8	30	100	76.5	23.5
P9	30	100	76.5	23.5
P10	30	100	76.5	23.5
P11	30	100	76.5	23.5
P12	30	100	76.5	23.5
P13	30	100	76.5	23.5
P14	30	100	76.5	23.5
P15	30	100	75.5	24.5
P16	30	100	75.5	24.5
P17	30	100	75.5	24.5
P18	30	100	75.5	24.5
P19	30	100	75.5	24.5
P20	30	100	75.5	24.5
P21	30	100	75.5	24.5
P22	30	100	75.5	24.5
P23	30	100	75.5	24.5
P24	30	100	75.5	24.5
P25	30	100	75.5	24.5
P26	30	100	75.5	24.5
P27	30	100	75.5	24.5
P28	30	100	75.5	24.5

1) TOP OF PIER CONCRETE ELEVATION IS 3" BELOW THE EDGE OF ROADWAY SURFACE.
2) ACTUAL LENGTH TO BE DETERMINED BY CONDITIONS IN FIELD. PLUG PIERS SHOULD EXTEND A MINIMUM OF 12" INTO BEDROCK.

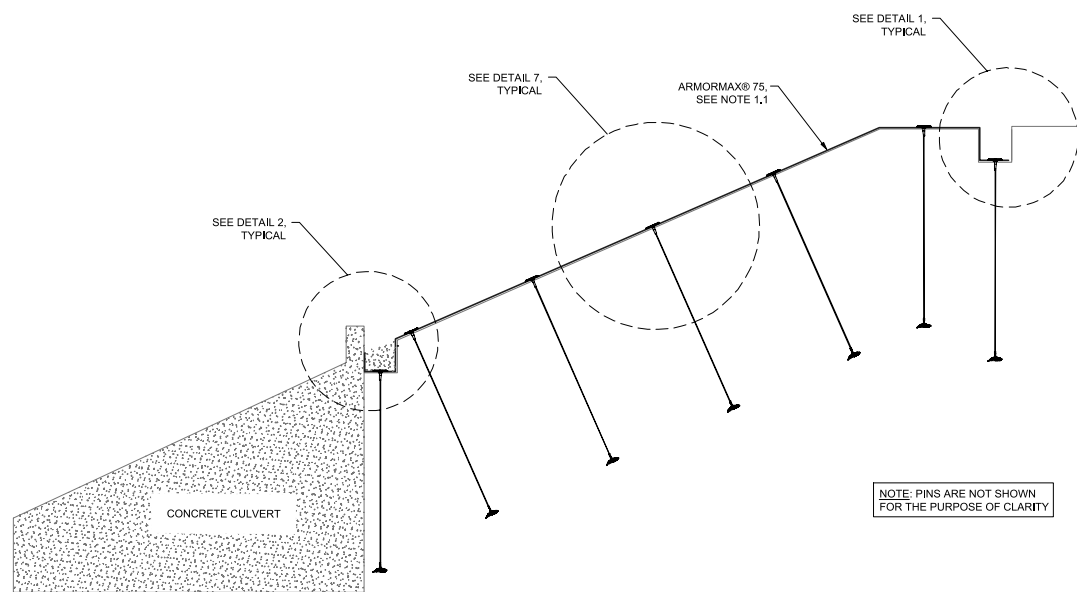

ELEVATION 1: INSTALLATION OF ARMORMAX@ 75 ON A SLOPE

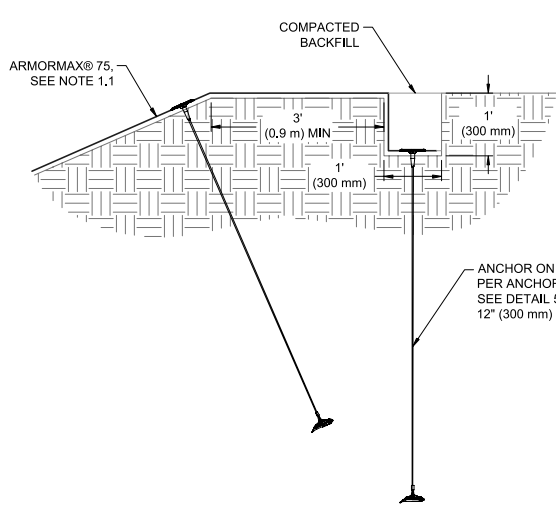

DETAIL 1: CREST OF SLOPE (COS) TRENCH

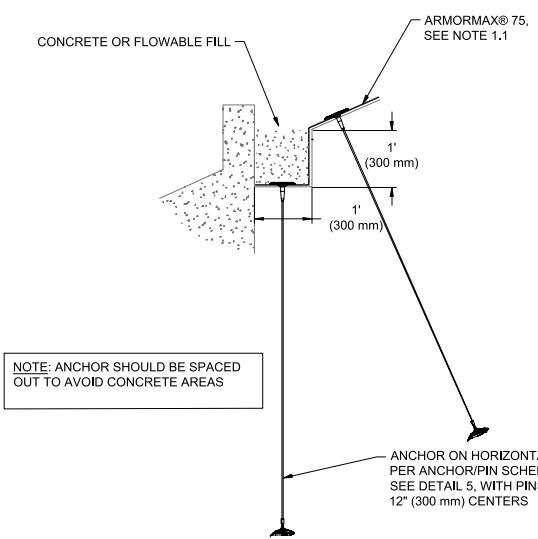

DETAIL 2: LOWER TERMINATION TRENCH AT CULVERT WALL WITH ANCHOR

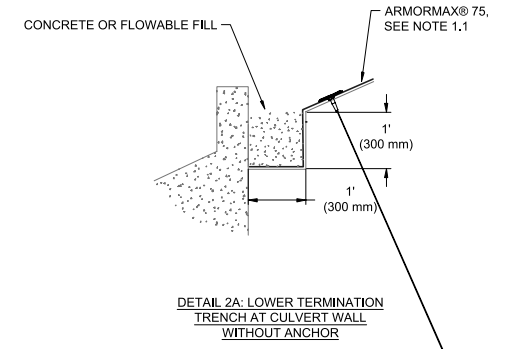

DETAIL 2A: LOWER TERMINATION TRENCH AT CULVERT WALL WITHOUT ANCHOR

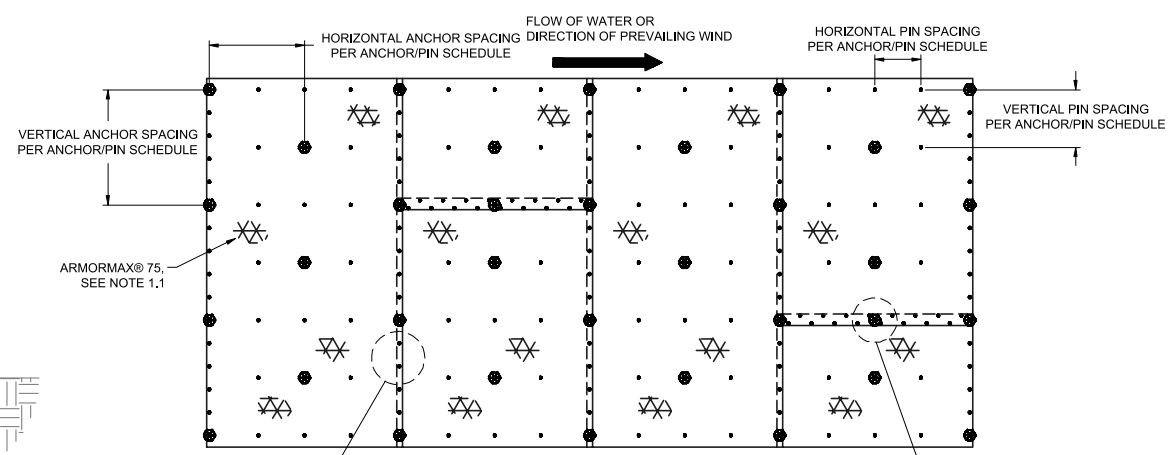

DETAIL 4: PIN PATTERN AND OVERLAPS

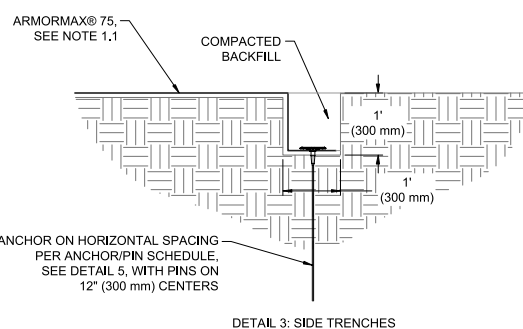

DETAIL 3: SIDE TRENCHES

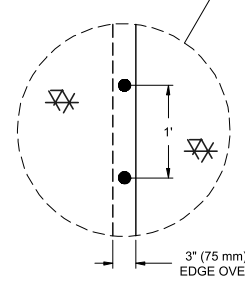

DETAIL 5: ENGINEERED EARTH ANCHOR

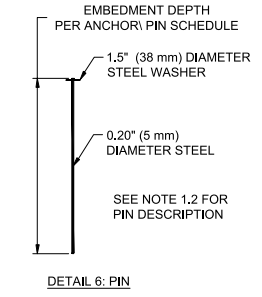

DETAIL 6: PIN

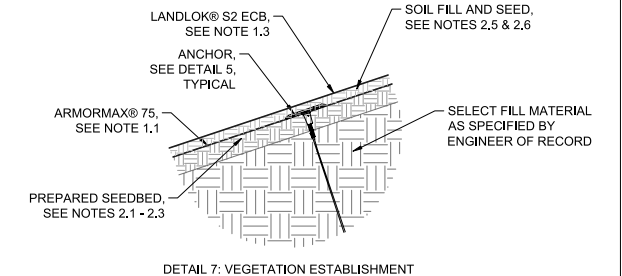

DETAIL 7: VEGETATION ESTABLISHMENT

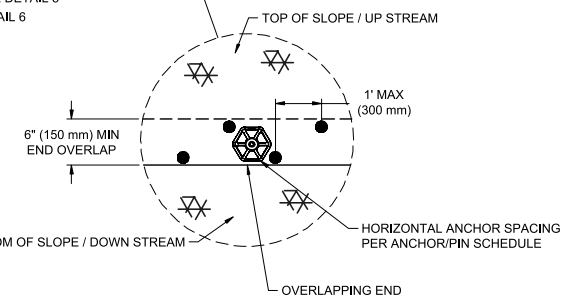

ANCHOR/PIN SCHEDULE		
SECURING DEVICE	ANCHOR	PIN
HORIZONTAL ANCHOR SPACING	4'	2'
VERTICAL ANCHOR SPACING	4'	2.5'
EMBEDMENT DEPTH	6'	1.5'

ARMORMAX@ 75 ON A SLOPE FOR SURFICIAL STABILITY (STRUCTURAL APPLICATION) GENERAL INSTALLATION GUIDELINES

- GENERAL NOTES**
 - ARMORMAX@ 75 is an engineered solution used for permanent erosion protection or surficial slope stability in vegetated and unvegetated applications. It is composed of two components: PYRAMAT@ 75 High Performance Turf Reinforcement Mat (HPTRM) and Engineered Earth Anchors. ARMORMAX@ 75 is available in green or tan to provide for an aesthetically pleasing solution with proven performance.
 - PYRAMAT@ 75 HPTRM is a three-dimensional, lofty, woven polypropylene geotextile that is available in green or tan which is specially designed for erosion control applications on steep slopes and vegetated waterways. The matrix is composed of polypropylene monofilament yarns featuring X3@ technology woven into a uniform configuration of resilient pyramid-like projections. The material exhibits very high interlock and reinforcement capacity with both soil and root systems, demonstrates superior UV resistance, and enhances seedling emergence.
 - The B2 Anchor model is used for surficial slope stability applications and has a working load of up to 1500 lbs. The B2 Anchor consists of an aluminum anchor head, galvanized steel cable, aluminum ferrules, aluminum load-locking mechanism, and an aluminum top plate. The B2 Anchor is also designed with a recessed cavity so the top of the cable can be cut below the surface being protected.
 - The 12", 18", and 24" Securing Pins are composed of a wire, mushroomed at the top. A washer is then placed on the wire and the wire is crimped or swaged about 3-1/2" below the top so the washer will not slide off. The end of the wire is cut at a 45 degree angle for easy penetration of the soil. These Pins with washers conform to industry standards for erosion control pins with washers.
 - LANDLOK@ S2 Erosion Control Blankets consist of 100% wheat straw mechanically bound and covered on both sides by netting. The straw is homogeneously blended and evenly distributed throughout the blanket. The netting is photodegradable polypropylene with mesh openings of approximately 3/8 in. by 3/8 in. (11 mm by 11 mm). The blanket is sewn on approximately 2 in. (51 mm) centers with photodegradable polypropylene thread. This product is NTPEP approved for AASHTO standards.
- VEGETATION ESTABLISHMENT**
 - Prepare seedbed by loosening/scarifying top 2 to 3 in. (50 to 75 mm) of the soil surface.
 - Apply any necessary soil amendments needed to promote healthy vegetation.
 - Sow 25-35% of the total permanent seed mixture to the prepared seedbed. Note this seed mixture amount is in addition to the 100% total seed mixture being applied in further steps.
 - Install ARMORMAX@ 75 per guidelines and specifications.
 - Soil fill the ARMORMAX@ 75 with 1 to 2 in. (25 to 50 mm) of amended topsoil or fill with a biotic soil media. Do not place excessive soil above the ARMORMAX@ 75 material.
 - Apply 100% of the total permanent seed mixture onto the topsoil/biotic soil media by broadcasting. Sown seed may need to be raked into place to ensure good contact between seed and soil.
 - Install surficial protection with LANDLOK@ S2 Erosion Control Blanket (ECB). LANDLOK@ S2 ECB is to be secured using 6" U-shaped staples with a frequency of 1.7 staples per square yard (2.0 staples per square meter).
 - Water and/or irrigate seeded areas as needed to establish and maintain vegetation until the desired vegetative density has been achieved. Frequent, light irrigation will need to be applied to seeded areas if natural rain events have not occurred within two weeks of seeding.
 - Rubber-tired or rubber-tracked vehicles shall be used, and sharp turns avoided. No heavy and/or metal tracked equipment or sharp turns shall be permitted on the installed ARMORMAX@ 75. Foot traffic and construction equipment shall be avoided over the ARMORMAX@ 75 if loose or wet soil conditions exist.

- BEFORE INSTALLATION BEGINS**
- Coordinate with a Propex Representative: A pre-construction meeting is suggested with the construction team and a representative from Propex. This meeting should be scheduled by the contractor with at least a two week notice.
 - Gather the Tools Needed: Tools that you will need to install ARMORMAX@ 75 include a pair of industrial shears to cut PYRAMAT@ 75, tape measure, percussion hammer (sized appropriately for the anchors), ground rod driver compatible with the percussion hammer, drive steel compatible with the anchor, setting tool to set and load-lock the anchor, and wire cutters to cut the cable tendon of the anchor. If anchors will be load tested during construction, additional testing equipment may be necessary. Consult the "Anchor Load Test Manual" from Propex for further guidance. Available for purchase from Propex are drive steel, setting tools, and wire cutters.
 - Determine how to Establish Vegetation: The method of vegetation establishment should be determined prior to the start of installation. Different vegetation establishment methods require different orders of installation. Refer to Establish Vegetation for further guidance.
 - A site specific soil test should be conducted to determine the recommended soil amendments required to establish permanent vegetation.
 - Please consult the Propex Website for the most up to date installation guidelines.



NOTE: THE STANDARD DETAILS ILLUSTRATED IN THESE DRAWINGS ARE FOR INFORMATION AND EVALUATION PURPOSES ONLY AND ARE NOT FOR CONSTRUCTION. PROJECT SPECIFIC CALCULATIONS, SHOP DRAWINGS AND SPECIFICATIONS, SIGNED AND SEALED BY A REGISTERED LICENSED ENGINEER, ARE REQUIRED FOR CONSTRUCTION.

CONCEPTUAL INSTALLATION DETAILS
ARMORMAX@ 75 FOR SLOPES

DATE:	SCALE:	SHEET	OF
10/18/2023	NTS	1	1

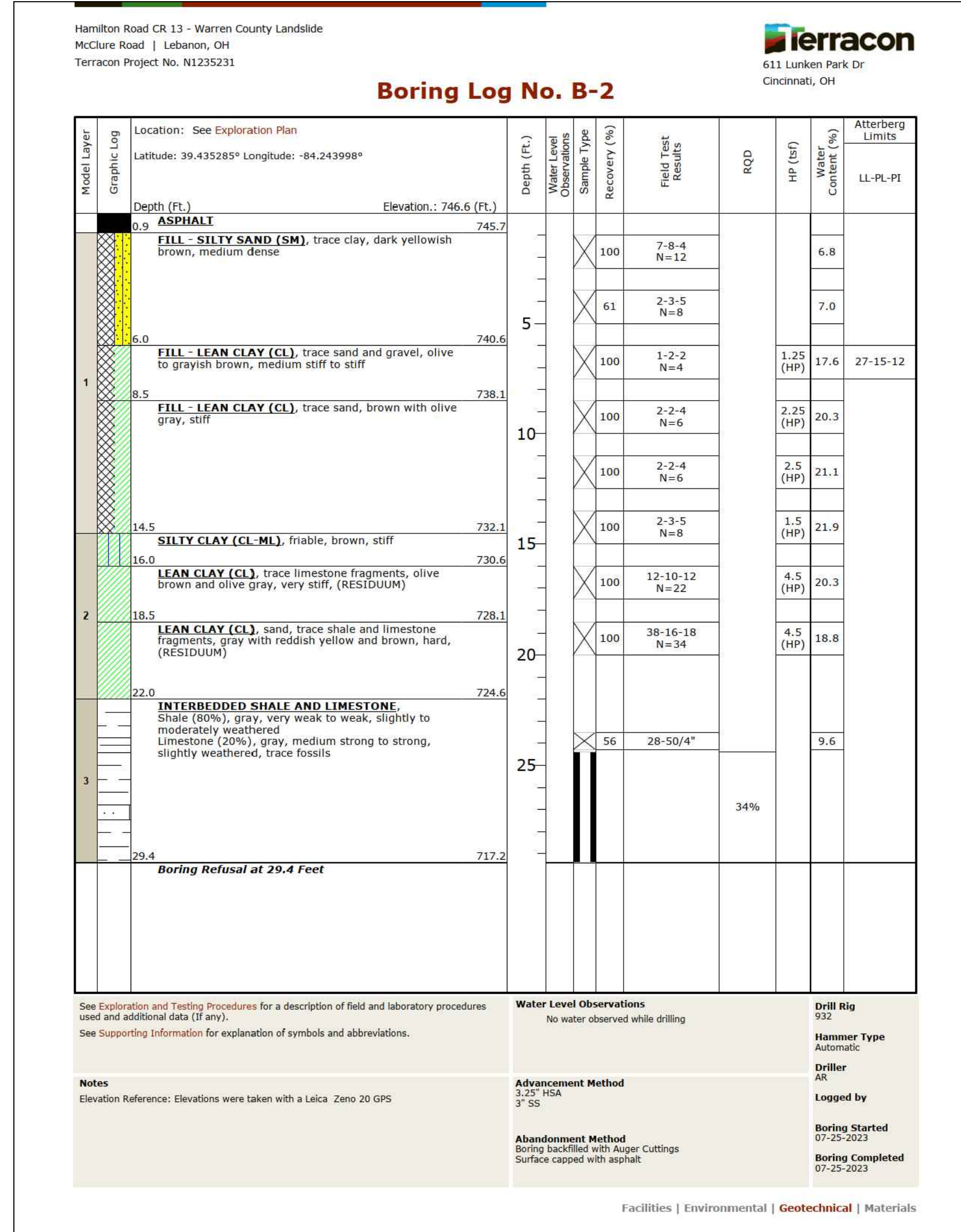
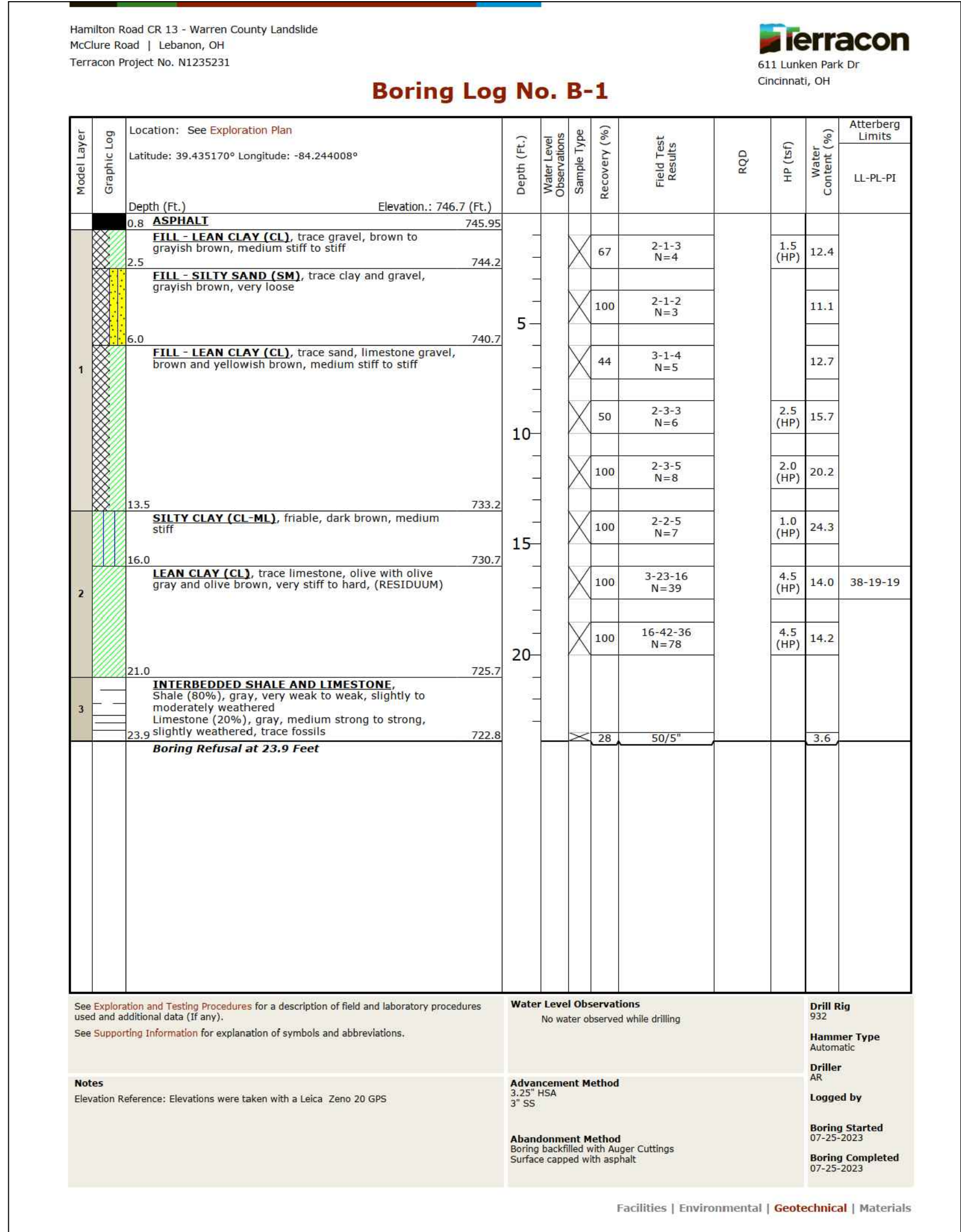

REV | DATE | BY

BORING LOGS
LANDSLIDE REMEDIATION
WARREN COUNTY ENGINEER'S OFFICE
WARREN COUNTY, OHIO

Terracon
Consulting Engineers and Scientists
611 LUNKEN PARK DRIVE
PH: (513) 521-5816
CINCINNATI, OHIO 45228
WWW.TERRACON.COM

EXHIBIT 6

DESIGNED BY:	PO
DRAWN BY:	DAB
APPVD. BY:	DWW
SCALE:	as noted
DATE:	12/5/2023
JOB NO.:	N1235231
ACAD NO.:	planset6
SHEET NO.:	6 OF 6

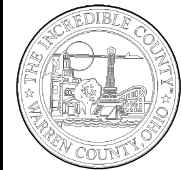
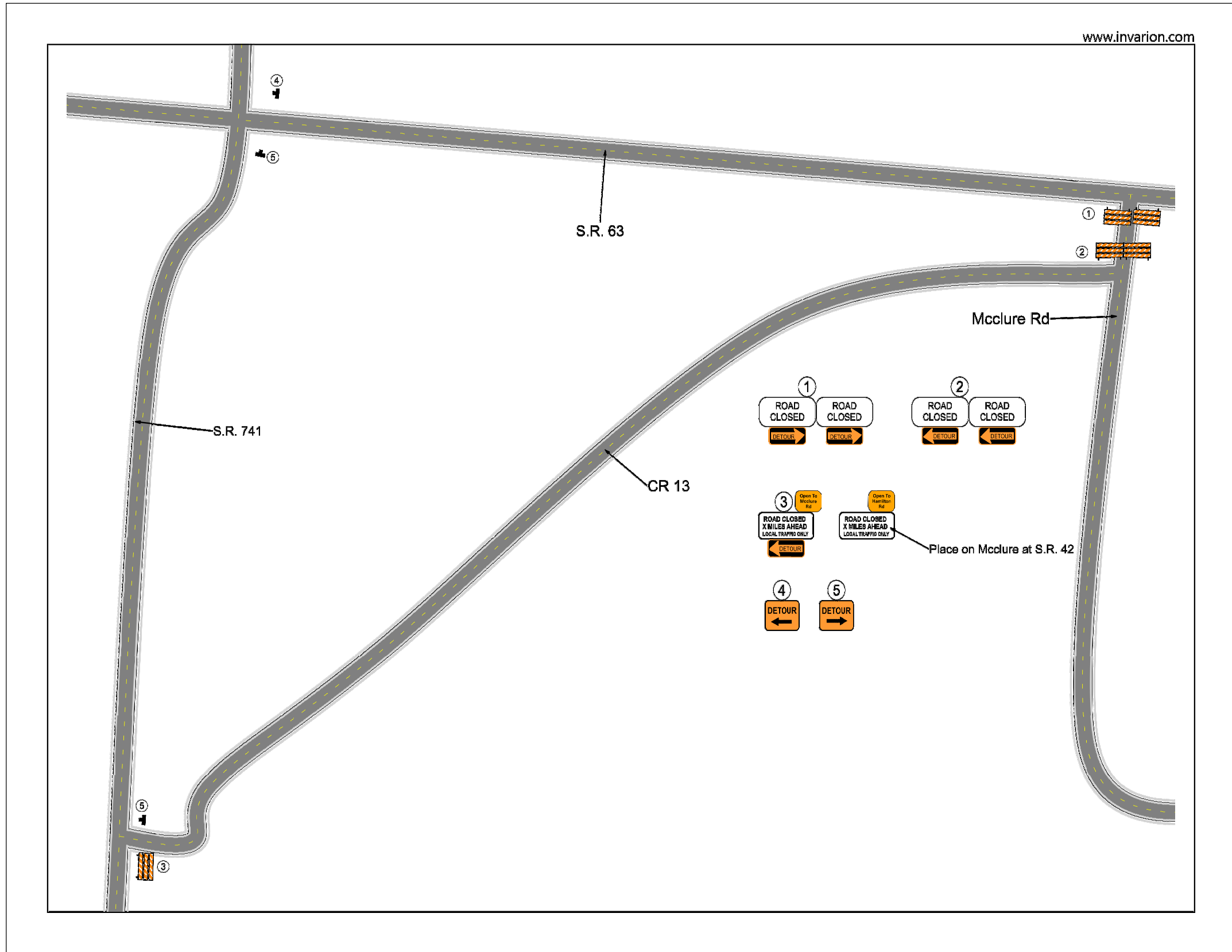

**Warren
County
Engineer's
Office**

Neil S. Junison, P.E., P.S.
Warren County Engineer
210 W. Main Street
Lebanon, Ohio 45036
513 695 3301 Phone
513 695 7714 Fax

DETOUR SHEET
 HAMILTON ROAD
 LANDSLIDE REMEDIATION
 TURTLECREEK TOWNSHIP

REVISIONS		DATE
NO.	DESCRIPTION	DATE

SCALE	DATE
(H) 1" = 10'	12/14/2025
(V) 1" = 5'	
DRAWN BY	CHECKED BY
LKS	DWB
PROJECT NO.	FILE
15-9-80	CR13 Landslide Remediation
DRAWING NO.	
SHEET 7 OF 7	



BOARD OF COUNTY COMMISSIONERS
WARREN COUNTY, OHIO

406 Justice Drive, Lebanon, Ohio 45036

www.co.warren.oh.us

commissioners@co.warren.oh.us

Telephone (513) 695-1250

Facsimile (513) 695-2054

SHANNON JONES
DAVID G. YOUNG
TOM GROSSMANN

ADVERTISEMENT FOR BIDS

Sealed bids will be received by the Clerk of the County Commissioners, Warren County, Ohio, 406 Justice Drive, Lebanon, Ohio 45036, until 9:30 a.m., August 14, 2024, and then at said time bids will be opened and read aloud for the 2024 Hamilton Road Drilled Pier Wall Project.

Bid documents and specifications are available online at the Warren County's Website at <https://www.co.warren.oh.us/commissioners/Bids/Default.aspx>. Questions regarding the technical specifications should be directed to Logan Smith, Project Engineer, at the Warren County Engineer's Office, at (513) 695-3318. Each bid shall contain the full name of each person or company submitting the bid and be accompanied by a bid bond for the full amount of the bid or a certified check in the amount equal to ten (10) percent of the bid.

Contact the Warren County Commissioner's Office at (513) 695-1250 should you need assistance in accessing the bidding information on the County's website. All contract addenda will be posted to the website prior to the bid opening. Bidders should check the website regularly to stay updated on any changes to the project.

Please be aware that if you are downloading this document to bid this project, and in order to stay updated on any change, please email Jeff Stilgenbauer in the Commissioners' Office at jeffery.stilgenbauer@co.warren.oh.us with your contact information.

The Board of Warren County Commissioners reserves the right to accept the lowest and best bid, to reject all bids, and to waive any irregularities in bids.

By order of the Board of County Commissioners, Warren County, Ohio.

Krystal Powell, Clerk